



**Instructions for the following series products:**

Sealed SRL

(See back page for specific model numbers.)

**USER INSTRUCTION MANUAL  
SEALED SELF RETRACTING LIFELINES**

*This manual is intended to meet the Manufacturer's Instructions as required by ANSI Z359.1 and the Canadian Standards Association, and should be used as part of an employee training program as required by OSHA.*

**WARNING:** *This product is part of a personal fall arrest or rescue system. These instructions must be provided to the user and rescuer (see section 8.0 Terminology). The user must read and understand these instructions or have them explained to them before using this equipment. The user must read and follow the manufacturer's instructions for each component or part of the complete system. Manufacturer's instructions must be followed for proper use and maintenance of this product. The user must read and follow the manufacturer's instructions for each component or part of the complete system. Alterations or misuse of this product or failure to follow instructions may result in serious injury or death.*

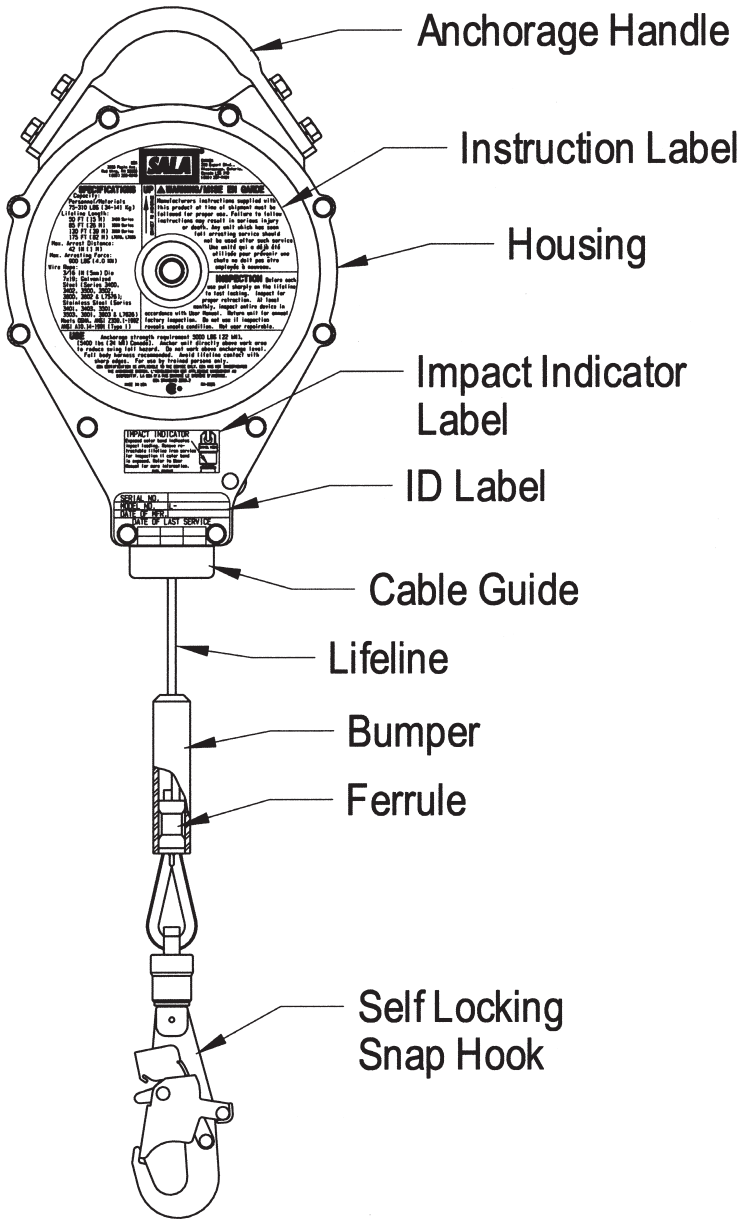
**IMPORTANT:** *If you have questions on the use, care, application, or suitability of this safety equipment, contact DBI-SALA.*

**IMPORTANT:** *Before using this equipment record the product identification information from the ID label in the inspection and maintenance log in section 10.0 of this manual.*

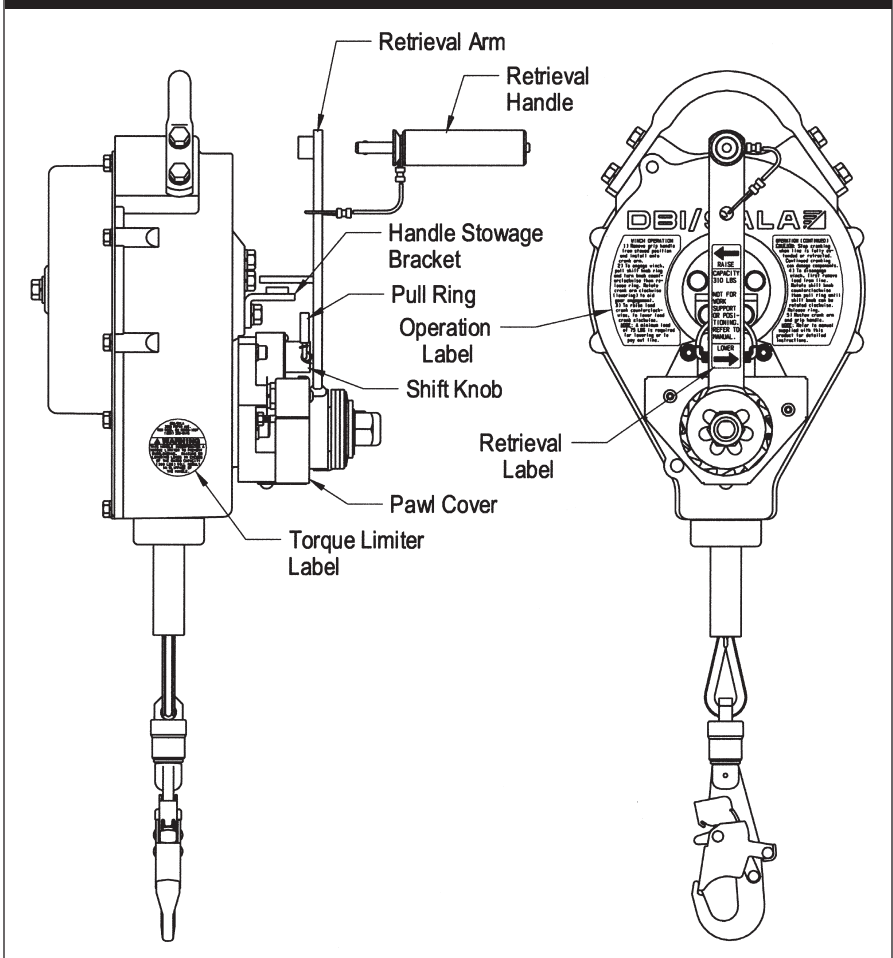




**Figure 1 - Self Retracting Lifeline Parts Identification**



**Figure 2 - Retrieval Parts Identification**



## **DESCRIPTIONS**

**3403400 Sealed Self Retracting Lifeline:** 50 ft. of 3/16 inch galvanized wire rope, self locking swiveling snap hook with indicator.

**3403401 Sealed Self Retracting Lifeline:** 50 ft. of 3/16 inch stainless steel wire rope, self locking swiveling snap hook with indicator.

**3403402 Sealed Self Retracting Lifeline with Retrieval:** 50 ft. of 3/16 inch galvanized wire rope, self locking swiveling snap hook with indicator.

**3403403 Sealed Self Retracting Lifeline with Retrieval:** 50 ft. of 3/16 inch stainless steel wire rope, self locking swiveling snap hook with indicator.

**3403500 Sealed Self Retracting Lifeline:** 85 ft. of 3/16 inch galvanized wire rope, self locking swiveling snap hook with indicator.

**3403501 Sealed Self Retracting Lifeline:** 85 ft. of 3/16 inch stainless steel wire rope, self locking swiveling snap hook with indicator.

**3403502 Sealed Self Retracting Lifeline with Retrieval:** 85 ft. of 3/16 inch galvanized wire rope, self locking swiveling snap hook with indicator.

**3403503 Sealed Self Retracting Lifeline with Retrieval:** 85 ft. of 3/16 inch stainless steel wire rope, self locking swiveling snap hook with indicator.

- 3403600 Sealed Self Retracting Lifeline:** 130 ft. of 3/16 inch galvanized wire rope, self locking swiveling snap hook with indicator.
- 3403601 Sealed Self Retracting Lifeline:** 130 ft. of 3/16 inch stainless steel wire rope, self locking swiveling snap hook with indicator.
- 3403602 Sealed Self Retracting Lifeline with Retrieval:** 130 ft. of 3/16 inch galvanized wire rope, self locking swiveling snap hook with indicator.
- 3403603 Sealed Self Retracting Lifeline with Retrieval:** 130 ft. of 3/16 inch stainless steel wire rope, self locking swiveling snap hook with indicator.
- 3400610 Sealed Self Retracting Lifeline:** 175 ft. of 3/16 inch galvanized wire rope, self locking swiveling snap hook with indicator.
- 3400611 Sealed Self Retracting Lifeline:** 175 ft. of 3/16 inch stainless steel wire rope, self locking swiveling snap hook with indicator.
- 3403404 Sealed Self Retracting Lifeline with Retrieval:** 30 ft. of 1/4 inch Spectra synthetic rope, self locking swiveling snap hook with indicator.
- 3403405 Sealed Self Retracting Lifeline:** 30 ft. of 1/4 inch Spectra synthetic rope, self locking swiveling snap hook with indicator.
- 3403504 Sealed Self Retracting Lifeline with Retrieval:** 55 ft. of 1/4 inch Spectra synthetic rope, self locking swiveling snap hook with indicator.
- 3403505 Sealed Self Retracting Lifeline:** 55 ft. of 1/4 inch Spectra synthetic rope, self locking swiveling snap hook with indicator.
- 3403604 Sealed Self Retracting Lifeline with Retrieval:** 80 ft. of 1/4 inch Spectra synthetic rope, self locking swiveling snap hook with indicator.
- 3400113 Sealed Self Retracting Lifeline with Retrieval:** 30 ft. of 1/4 inch Technora synthetic rope, self locking swiveling snap hook with indicator. Mounting bracket included.

## 1.0 APPLICATIONS

- 1.1 PURPOSE:** DBI-SALA self retracting lifelines (SRL) are designed to be components in personal fall arrest systems (PFAS). They may be used in most situations where a combination of worker mobility and fall protection is required (i.e. inspection work, general construction, maintenance work, oil production, confined space work, etc.). Some SRL models incorporate a built-in retrieval feature. These models have the same fall arrest capabilities as those described above when used in their non-retrieval mode. In the retrieval mode these models may be used for emergency rescue (raising or lowering) of personnel within the capacity range stated below. It is also permissible to use retrieval models for raising and lowering of materials within the stated capacity range.

**IMPORTANT:** *This equipment may not be suitable for applications requiring frequent or continual use as a material hoist. Consult DBI-SALA before using this product for such applications. The retrieval models listed above are not designed to be used for general purpose work positioning or man-riding applications.*

- 1.2 LIMITATIONS:** The following application limitations must be considered before using this product:
- A. CORROSION:** Do not leave this equipment for long periods in environments where corrosion of metal parts could occur as a result of vapors from organic materials. Use caution when

working around sewage or fertilizer because of their high concentration of ammonia, which is very corrosive. Use near seawater or other corrosive environments may require more frequent inspections or servicing to assure corrosion damage is not affecting the performance of the product.

- B. CHEMICAL HAZARDS:** Solutions containing acids, alkali or other caustic chemicals, particularly at elevated temperatures, may damage DBI-SALA SRL's. When working with such chemicals, frequent inspection of the entire SRL must be completed. Chemical damage to the lifeline is difficult to detect and it is recommended that the lifeline be replaced periodically to ensure safety. The lifeline may only be replaced by an authorized service center. Consult DBI-SALA if in doubt about using this equipment around chemical hazards.
- C. HEAT:** This equipment is not designed for use in high temperature environments. Provide protection for this equipment when using near welding, metal cutting, or similar activities. Hot sparks may burn or damage this equipment. Consult DBI-SALA for details on use in high temperature environments.

**NOTE:** SRL's using Spectra synthetic rope are not flame or heat resistant. Do not use in environments exceeding 140°F (60°C). Do not allow Spectra rope to contact materials exceeding 140°F (60°C). SRL's using Technora synthetic rope are heat resistant up to 900°F (480°C).

- D. ELECTRICAL HAZARDS:** Due to the possibility of electric current flowing through the wire rope lifeline, use extreme caution when working near high voltage power lines.
- E. CAPACITY:** These SRL's are designed for use by persons with a combined weight (person, clothing, tools, etc.) of 75 lbs. to 310 lbs. At no time shall more than one person connect to a single SRL for fall arrest applications.
- F. LOCKING SPEED:** Situations which do not allow for an unobstructed fall path should be avoided. Working in confined or cramped spaces may not allow the body to reach sufficient speed to cause the SRL to lock if a fall occurs. Working on slowly shifting material, such as sand or grain, may not allow enough speed buildup to cause the SRL to lock. A clear path is required to assure positive locking of the SRL.
- G. NORMAL OPERATIONS:** Normal operation will allow the full length of the lifeline to extend and retract with no hesitation when extending and no slack when retracting as the worker moves at normal speeds. If a fall occurs a speed sensing brake system will activate, stopping the fall and absorbing much of the energy created. For falls which occur near the end of the lifeline travel a reserve lifeline system has been incorporated to assure a reduced impact fall arrest. If a fall has been arrested,

the SRL must be taken out of service and inspected. See section 5.0. Sudden or quick movements should be avoided during the normal work operation, this may cause the SRL to lockup.

**H. TRAINING:** This equipment is intended to be installed and used by persons who have been trained in its correct application and use.

**1.3** Refer to national Standards including ANSI Z359 (.0, .1, .2, .3, and .4) family of standards on fall protection, ANSI A10.32, and applicable local, state and federal (OSHA) requirements governing occupational safety for more information on anchorage connectors and associated components.

## **2.0 SYSTEM REQUIREMENTS**

**2.1 COMPATIBILITY OF COMPONENTS:** DBI-SALA equipment is designed for use with DBI-SALA approved components and subsystems only. Substitutions or replacements made with non-approved components or subsystems may jeopardize compatibility of equipment and may effect the safety and reliability of the complete system.

**2.2 COMPATIBILITY OF CONNECTORS:** Connectors are considered to be compatible with connecting elements when they have been designed to work together in such a way that their sizes and shapes do not cause their gate mechanisms to inadvertently open regardless of how they become oriented. Contact DBI-SALA if you have any questions about compatibility.

Connectors (hooks, carabiners, and D-rings) must be capable of supporting at least 5,000 lbs. (22.2kN). Connectors must be compatible with the anchorage or other system components.

Do not use equipment that is not compatible. Non-compatible connectors may unintentionally disengage. See Figure 3.

Connectors must be compatible in size, shape, and strength. Self locking snap hooks and carabiners are required by ANSI Z359.1 and OSHA.

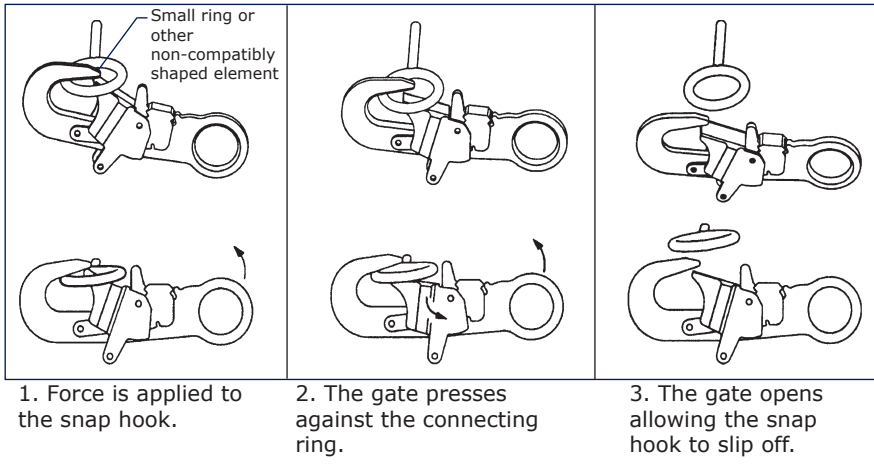
**2.3 MAKING CONNECTIONS:** Only use self-locking snap hooks and carabiners with this equipment. Only use connectors that are suitable to each application. Ensure all connections are compatible in size, shape and strength. Do not use equipment that is not compatible. Ensure all connectors are fully closed and locked.

DBI-SALA connectors (snap hooks and carabiners) are designed to be used only as specified in each product's user's instructions. See Figure 4 for inappropriate connections. DBI-SALA snap hooks and carabiners should not be connected:

**A.** To a D-ring to which another connector is attached.

**Figure 3 - Unintentional Disengagement (Roll-out)**

If the connecting element that a snap hook (shown) or carabiner attaches to is undersized or irregular in shape, a situation could occur where the connecting element applies a force to the gate of the snap hook or carabiner. This force may cause the gate (of either a self-locking or a non-locking snap hook) to open, allowing the snap hook or carabiner to disengage from the connecting point.



**B.** In a manner that would result in a load on the gate.

**NOTE:** Large throat opening snap hooks should not be connected to standard size D-rings or similar objects which will result in a load on the gate if the hook or D-ring twists or rotates. Large throat snap hooks are designed for use on fixed structural elements such as rebar or cross members that are not shaped in a way that can capture the gate of the hook.

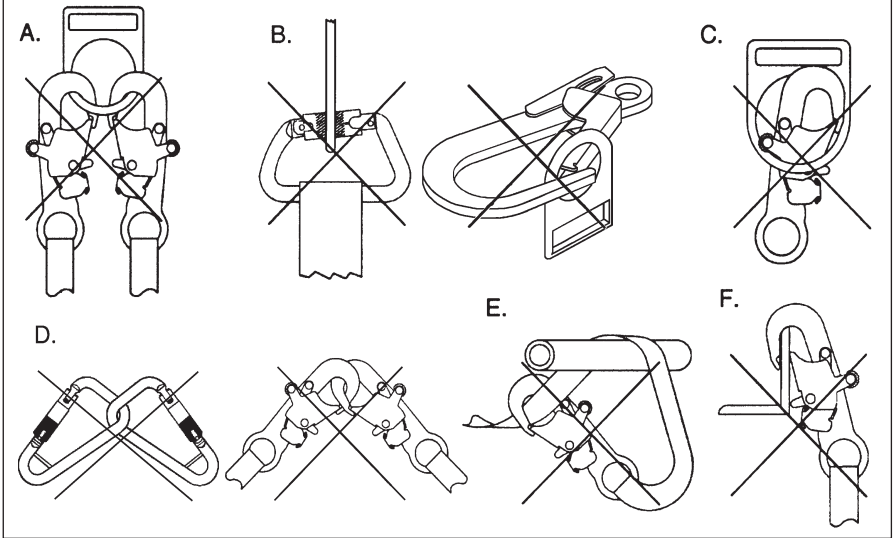
- C.** In a false engagement, where features that protrude from the snap hook or carabiner catch on the anchor and without visual confirmation seems to be fully engaged to the anchor point.
- D.** To each other.
- E.** Directly to webbing or rope lanyard or tie-back (unless the manufacturer's instructions for both the lanyard and connector specifically allow such a connection).
- F.** To any object which is shaped or dimensioned such that the snap hook or carabiner will not close and lock, or that roll-out could occur.

**2.4 ANCHORAGE STRENGTH:** The anchorage strength required is dependent on the application type. The following are the requirements of ANSI 359.1 for these application types:

- A. FALL ARREST:** Anchorages selected for fall arrest systems shall have a strength capable of sustaining static loads applied



**Figure 4 - Inappropriate Connections**



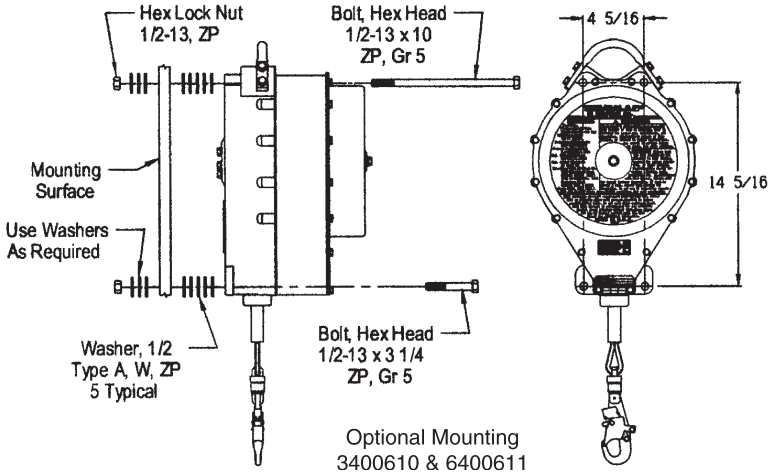
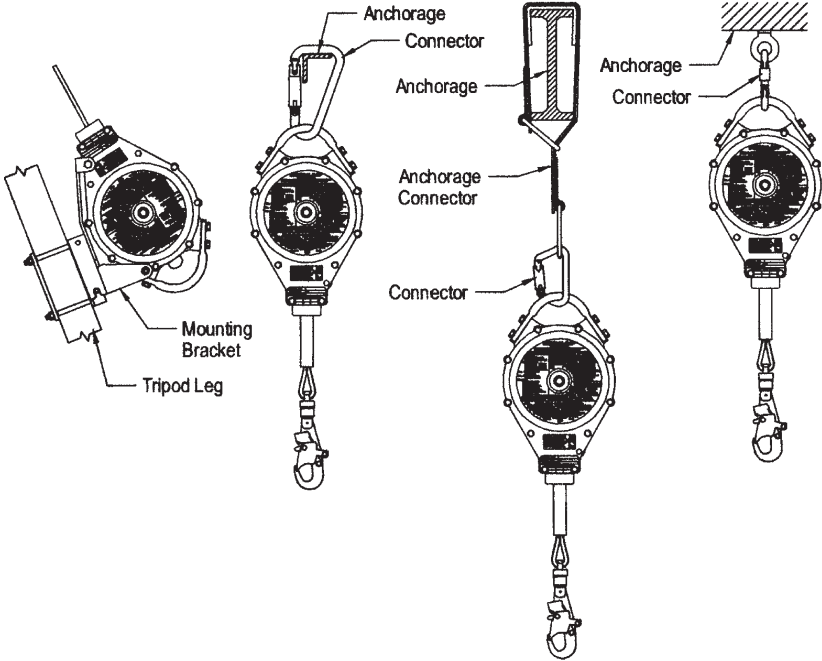
in the directions permitted by the system of at least:

1. 5,000 lbs. (22.2 kN) for non-certified anchorages, or
2. Two times the maximum arresting force for certified anchorages. When more than one fall arrest system is attached to an anchorage, the strengths set forth in (1) and (2) above shall be multiplied by the number of systems attached to the anchorage.

- B. RESCUE:** Anchorages selected for rescue systems shall have a strength capable of sustaining static loads applied in the directions permitted by the system of at least:
1. 3,000 lbs. (13.3 kN) for non-certified anchorages, or
  2. Five times the foreseeable force for certified anchorages. When more than one rescue system is attached to an anchorage, the strengths set forth in (1) and (2) above shall be multiplied by the number of systems attached to the anchorage.

- 2.5** In applications where an SRL is used in conjunction with a horizontal system (i.e. horizontal I-beams and trolleys), the SRL and horizontal system components must be compatible.
- 2.6** When using DBI-SALA SRL's with optional retrieval system, ensure the support structure (i.e. tripod, davit arm) is compatible with connection of the SRL, and compatible with the operation, stability, and strength of the SRL. See Figure 5.

**Figure 5 - Anchorage and Connections**



### 3.0 OPERATION AND USE

**WARNING:** Do not alter or intentionally misuse this equipment. Consult DBI-SALA when using this equipment in combination with components or subsystems other than those described in this manual. Some subsystem and component combinations may interfere with the operation of this equipment. Use caution when using this equipment around moving machinery, electrical hazards, chemical hazards, and sharp edges. Do not loop the lifeline around small structural members.

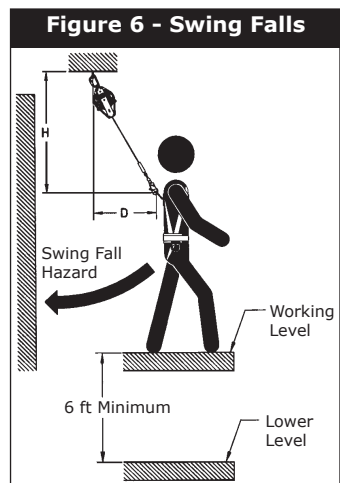
**WARNING:** Consult your doctor if there is reason to doubt your fitness to safely absorb the shock from a fall arrest. Age and fitness seriously affect a worker's ability to withstand falls. Pregnant women or minors must not use DBI-SALA self retracting lifelines.

**3.1 BEFORE EACH USE:** Before each use of this fall protection equipment carefully inspect it to assure it is in good working condition. Check for worn or damaged parts. Ensure all bolts are present and secure. Check that the lifeline is retracting properly by pulling out the line and allowing it to slowly retract. If there is any hesitation in retraction the unit should be returned to DBI-SALA for service. Inspect the lifeline for cuts, frays, burns, etc. Check locking action by pulling sharply on the line. See section 5.0 for inspection details. Do not use if inspection reveals an unsafe condition.

**3.2 PLANNING:** Plan your fall protection system before starting your work. Consider all factors that may affect your safety before, during, and after a fall. The following list gives some important points to consider when planning your system:

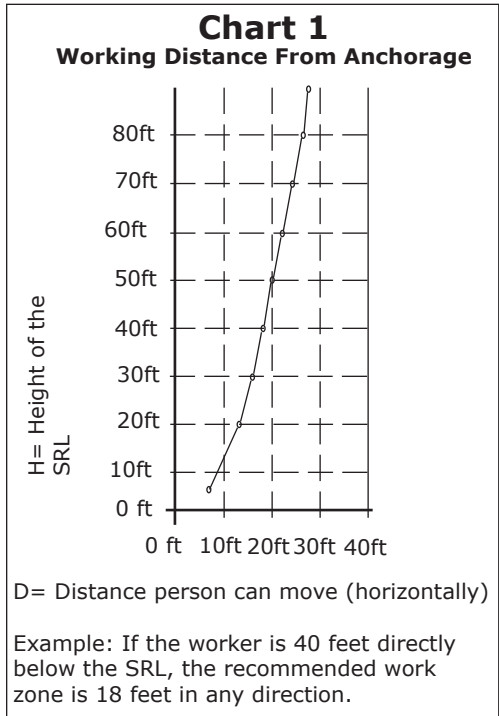
**A. ANCHORAGE:** Select a rigid anchorage point that is capable of supporting 5,000 lbs. (22.2kN). See Figure 5 and section 2.4. Carefully select the anchorage location to reduce free fall and swing fall hazards.

**B. FREE FALL:** Personal fall arrest systems must be rigged so the potential free fall is never greater than 6 feet. Do not work above your anchorage level to avoid an increased free fall distance. Avoid working where your lifeline may cross or tangle with that of another worker. Do not allow the lifeline to pass under arms or between legs. Never clamp, knot, or prevent the lifeline from retracting or being



taut. Avoid slack line. **Do not lengthen SRL by connecting a lanyard or similar component without consulting DBI-SALA.**

- C. SWING FALLS:** Swing falls occur when the anchorage point is not directly above the point where a fall occurs. See Figure 6. The force of striking an object in a swing fall may cause serious injury. In a swing fall, the total vertical fall distance will be greater than if the user had fallen directly below the anchorage point, thus increasing the total free fall distance and the area required to safely arrest the user. The SRL will activate regardless of its orientation relative to the user. The recommended work zone represents the typical acceptable work area for most applications. Review your specific application to determine what the appropriate work zone should be. See Chart 1. Minimize swing falls by working as directly below the anchorage point as possible. Never permit a swing fall if injury could occur. If a swing fall situation exists in your application contact DBI-SALA before proceeding.



- D. FALL CLEARANCE:** Ensure adequate clearance exists in your fall path to prevent striking an object. A minimum of 6 feet from the working level to the lower level or nearest obstruction is recommended. See Figure 6.
- E. SHARP EDGES:** Avoid working where the lifeline will be in contact with or abrade against unprotected sharp edges. Provide protection for the lifeline when possible. An energy absorbing component can sometimes be added in-line to further protect the worker. Compatibility and total fall distance must be considered if this is done. Contact DBI-SALA before using an in-line energy absorbing component or lanyard with an SRL.

**F. RESCUE:** When using this equipment, the employer must have a rescue plan and the means at hand to implement it and communicate that plan to users, authorized persons, and rescuers.

**G. AFTER A FALL:** Any equipment which has been subjected to the forces of arresting a fall or exhibits damage consistent with the effect of fall arrest forces as described in section 5, must be removed from service immediately and destroyed by the user, the rescuer, or an authorized person.

**WARNING:** Read and follow manufacturer's instructions for associated equipment (i.e. full body harness) used in your personal fall arrest system.

**IMPORTANT:** For special (custom) versions of this product, follow the instructions herein. See attached supplement, if included, for additional instructions when using a customized product.

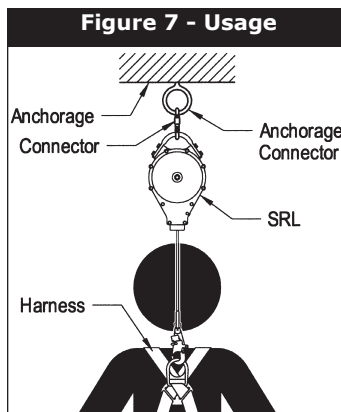
**3.3 BODY SUPPORT:** When using DBI-SALA SRL's a full body harness must be worn. For general fall protection use connect to the back D-ring. For situations such as ladder climbing, it may be useful to attach to the front of the harness. This is acceptable provided potential free fall is very short and footing can be easily regained.

For retrieval operations it is recommended that a full body harness be used to retrieve the victim, assuming their medical condition allows for such retrieval. Models are available with retrieval connections (shoulder D-rings) on top of the shoulders to aid in rescue operations.

**IMPORTANT:** Do not use a body belt for free fall applications. See OSHA 1926.502 for guidelines.

**3.4 MAKING CONNECTIONS:** When using a hook to make a connection, ensure roll-out cannot occur. See section 2.2. Do not use hooks or connectors that will not completely close over the attachment object. Do not use non-locking snap hooks. It is recommended that the 3400610 and 3400611 be attached to a structure in a fixed position (vs. hanging) with the hardware supplied. The mounting surface should meet the anchorage strength requirements stated in section 2.4. Follow the manufacturer's instructions supplied with each system component.

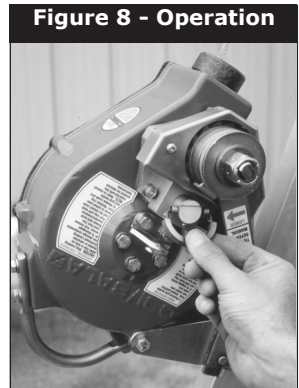
**IMPORTANT:** If longer bolts are needed to mount the SRL to a structure, use 1/2 in. diameter, grade 5 (minimum) bolts.



**3.5 OPERATION:** Inspect the SRL as described in section 3.1. Connect the SRL to a suitable anchorage or anchorage connector as previously described. Connect self locking snap hook on end of lifeline to the fall arrest or ladder climbing attachment on the body support (full body harness). See Figure 7. Ensure connections are compatible in size, shape, and strength. Ensure hook is fully closed and locked. Once attached, the worker is free to move about within the recommended working area at normal speeds. If a fall occurs the SRL will lock and arrest the fall. Upon rescue remove SRL from use. Inspect as described in section 5.0. When working with an SRL, always allow the lifeline to recoil back into the device under control. A short tag line may be required to extend or retract the lifeline during connection and disconnection operations.

**3.6 RETRIEVAL SYSTEM OPERATION:**

To activate retrieval mode, remove the retrieval handle on back side of the SRL by pushing the release button on top of handle and pulling upward. Install pin into hole on end of retrieval arm. Rotate arm assembly to the side to access shift knob. Lift pull ring on shift knob, rotate counterclockwise 1/8 turn and release. Rotate retrieval arm clockwise to aid engagement. **The shift knob should move inward and rotate to a locked position when drive is fully engaged.** See Figure 8.



**A. TO RAISE:** Rotate retrieval arm counterclockwise.

**B. TO LOWER:** Rotate retrieval arm clockwise. Keep tension on lifeline at all times (75 lbs. minimum).

**IMPORTANT:** *If a fall occurs in the fall arrest mode and the worker must be lowered to safety, raise the worker slightly to release the locking pawls and lower the worker.*

**IMPORTANT:** *Do not continue to rotate the retrieval arm in the lowering direction after the cable is fully extended. Spring damage may occur.*

**C. DISENGAGEMENT OF RETRIEVAL MODE:** Remove load from the lifeline. Rotate the shift knob counterclockwise 1/8 turn, pull ring out, rotate shift knob clockwise 1/8 turn. Release pull ring. Remove retrieval handle from retrieval arm and stow in stowage bracket. Insert retrieval handle pin through handle and into stowage bracket.

**3.7 RETRIEVAL OVERLOAD FEATURE:** SRL's which incorporate the retrieval feature are provided with an overload clutch which protects the drive components and the person being raised from excessive force. This same feature provides shock absorption for

the user if a fall occurs when the retrieval mode is engaged. The overload clutch is set to slip at approximately 500 lbs. to allow for emergency rescue applications where additional lifting capacity is required.

**IMPORTANT:** Operating the retrieval system at loads greater than the rated capacity reduces the overall safety factor. Any unit which has been used above the rated capacity must be removed from service and returned to DBI-SALA for inspection.

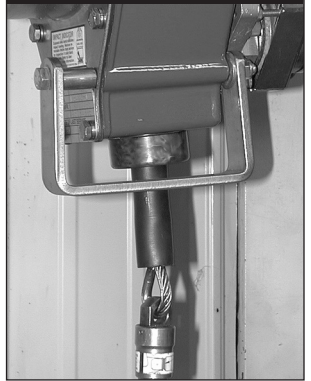
**3.8 MOUNTING RETRIEVAL MODELS:** The SRL retrieval models may be used with optional brackets for mounting to the DBI-SALA tripod, davit arm, or ladder mast. Follow the steps below for mounting and use of these brackets:

**IMPORTANT:** If mating bracket for tripod leg is not attached position clamp plate assembly in desired location on leg and tighten bolts to 15 foot lbs. Do not overtighten.

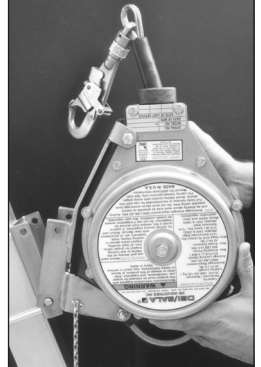
**NOTE:** For retrieval models operated from a free hanging position a hand stabilizing bracket (3401255) is available to steady the SRL. Attach bracket to the SRL housing using bolt, spacer, and washer furnished, which are inserted through the hole in the housing on the bottom half. See Figure 9.

- Step 1.** Attach the bracket to the SRL by inserting the two furnished bolts through the holes in the SRL housing. Attach nuts and secure.
- Step 2.** After the bracket is secured to the SRL, position the SRL bracket assembly onto mating bracket of tripod, davit arm, or ladder mast. The slot in the end of SRL bracket slides onto pin extending out each side of mating ladder mast, davit arm, or tripod leg bracket. Reposition tripod leg bracket as required for proper operating height. See Figure 10.
- Step 3.** With assembly resting on pin, pivot top of SRL inward to align holes. Press in button on end of detent pin and slide pin in fully to secure SRL assembly to tripod, davit arm, or ladder mast. See Figure 11.

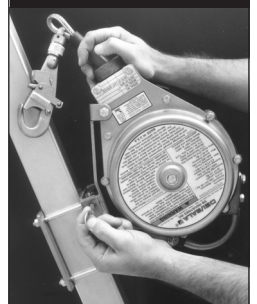
**Figure 9 - Free Hanging**



**Figure 10 - Step 2**



**Figure 11 - Step 3**





- Step 4.** Extend cable up support structure and over pulleys. Reinstall detent pins near pulley to prevent cable from sliding off pulleys. See Figure 12. Figures 13 and 14 show a completed attachment.

## 4.0 TRAINING

- 4.1** It is the responsibility of the user to assure they are familiar with these instructions, and are trained in the correct care and use of this equipment. User must also be aware of the operating characteristics, application limits, and the consequences of improper use of this equipment.

**IMPORTANT:** Training must be conducted without exposing the trainee to a fall hazard. Training should be repeated on a periodic basis.

## 5.0 INSPECTION

### 5.1 FREQUENCY:

- **Before Each Use:** OSHA 1910.66, OSHA 1926.502 and ANZI359.1 (in Canada - CSA Z259.2.2) Requires an inspection of equipment before each use. See 5.2, 5.3, and 5.4.
- **Annually:** ANSI Z359.1 requires a formal inspection of the SRL be completed by a competent person other than the user. More frequent inspections by a competent person may be required based on the nature and severity of workplace conditions affecting the equipment and the modes of use and exposure time of the equipment. See sections 5.2, 5.3, and 5.4 for inspection guidelines. Record results in the inspection and maintenance log in section 9.0.

NOTE: In Canada, CSA requires SRLs to be serviced within two years of the manufactured date, and annually thereafter.

A record of annual service dates can be found on the identification plate of the SRL. See Figure 1 and section 8.0.

- **After Fall Arrest:** Inspect load indicator according to section 5.2, and entire SRL per sections 5.3 and 5.4.

Figure 12 - Step 4



Figure 13



Figure 14





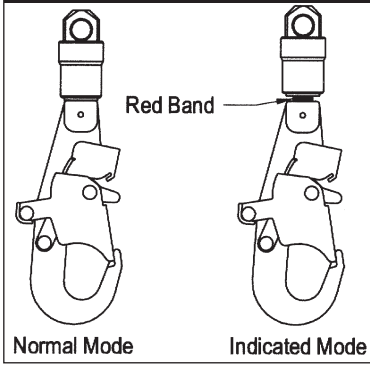
- **After Use Of Retrieval Mode:** After raising or lowering, inspect load indicator according to section 5.2 and entire SRL according to sections 5.3 and 5.4. Applications which require continuous raising and lowering may require increased inspection and servicing frequency. Contact DBI-SALA if you have any questions regarding inspection frequency.

**WARNING:** If the self retracting lifeline has been subjected to fall arrest or impact forces, it must be removed from service and inspected according to sections 5.2 and 5.3

**IMPORTANT:** Extreme working conditions (harsh environment, prolonged use) may require increasing the frequency of inspections.

**5.2 IMPACT INDICATOR:** To inspect the impact indicator, look for exposed color band on hook as shown in Figure 15. If the hook is in the “indicated mode”, an impact loading has occurred. SRL’s which have been subjected to impact loading must be removed from service for inspection. Do not attempt to reset impact indicator. Return to an authorized service center for resetting. NOTE: Swivel will not turn freely in “indicated mode”.

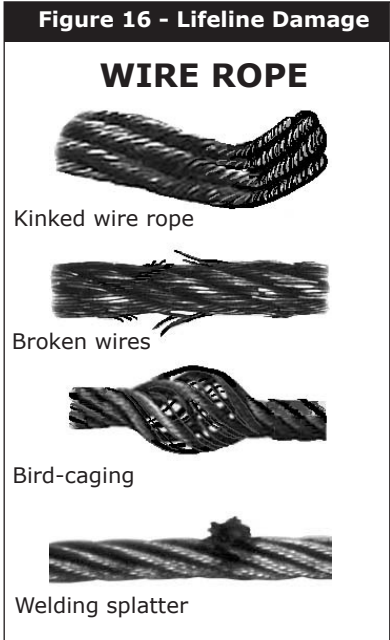
**Figure 15 - Impact Indicator**



**5.3 INSPECTION STEPS:**

- Step 1.** Inspect for loose bolts and bent or damaged parts.
- Step 2.** Inspect housing for distortion, cracks, or other damage.
- Step 3.** Lifeline should pull out and retract fully without hesitation or creating a slack line condition.
- Step 4.** Ensure device locks up when lifeline is jerked sharply. Lockup should be positive with no slipping.
- Step 5.** The labels must be present and fully legible. See section 9.0.
- Step 6.** Look for signs of corrosion on the entire unit.
- Step 7.** Inspect lifeline. On web or synthetic rope models, inspect lifeline for concentrated wear, frayed strands, broken yarn, burns, cuts, and abrasions. The lifeline must be free of knots throughout its length. Inspect for excessive soiling, paint buildup, and rust staining. Inspect for chemical or heat damage indicated by brown, discolored, or brittle areas. Inspect for ultraviolet damage indicated by discoloration and the presence of splinters and slivers on the lifeline surface.

**Step 8. WIRE ROPE:** Inspect wire rope for cuts, kinks, broken wires, bird-caging, welding splatter, corrosion, chemical contact areas, or severely abraded areas. (See Figure 16). Slide the cable bumper up and inspect ferrules for cracks or damage and inspect the wire rope for corrosion and broken wires. NOTE: Replace the wire rope assembly if there are six or more randomly distributed broken wires in one lay, or three or more broken wires in one strand in one lay. A "lay" of wire rope is the length of wire rope it takes for a strand (the larger groups of wires) to complete one revolution or twist along the rope. Replace the wire rope assembly if there are any broken wires within 1 inch (25mm) of the ferrules.



**SYNTHETIC ROPE (Spectra and Technora):** Inspect synthetic rope for concentrated wear, frayed strands, broken yarns, cuts, and abrasions. The lifeline must be free of knots throughout its length. Inspect for excessive soiling, paint buildup, and rust staining. Inspect for chemical or heat damage indicated by brown, discolored, or brittle areas. Inspect for ultraviolet damage indicated by discoloration and the presence of splinters and slivers on the rope surface. NOTE: All of the above factors are known to reduce rope strength. Rope strength is reduced proportional to the cross-sectional area of the rope damaged. Damaged or questionable ropes must be replaced.

**WARNING:** Do not tie or knot lifeline. Avoid lifeline contact with sharp or abrasive surfaces. Inspect lifeline frequently for cuts, fraying, burns, or signs of chemical damage. Dirt, contaminants, and water can lower dielectric properties of the lifeline. Use caution near power lines.

**Step 9.** Inspect connecting hooks for signs of damage, corrosion, and working condition. Swivel should rotate freely. Inspect impact indicator according to section 5.2.

**Step 10. WIRE ROPE MODELS:**

Inspect the reserve lifeline payout. If a fall has been arrested when most of the lifeline was out, it is possible that the reserve lifeline has been deployed. To inspect for reserve lifeline deployment, pull lifeline out of the SRL until it stops. If the reserve lifeline cable stop or cable guide sleeve is visible, the reserve lifeline has been spent and the unit must be serviced by an authorized service center before reuse. See Figure 17. If the reserve lifeline has not been deployed, that portion is acceptable and the inspection can continue.

**SYNTHETIC ROPE MODELS (Spectra and Technora):**

Inspect the reserve lifeline payout. If a fall has been arrested, it is possible the reserve lifeline has been deployed. To inspect for reserve lifeline deployment, pull lifeline out of the SRL until it stops. If the reserve lifeline warning label is visible, the reserve lifeline has been spent and the unit must be serviced by an authorized service center before use. See Figure 17. If the reserve lifeline has not been deployed (the reserve lifeline label is not visible) that portion is acceptable and the inspection can continue.

**Step 11.** Inspect each system component or subsystem according to manufacturer's instructions.

**Step 12.** Record inspection results in the inspection log found in section 10.0.

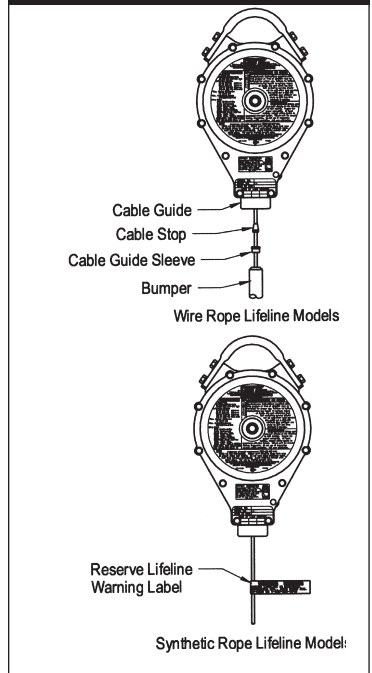
**INSPECTION STEPS FOR RETRIEVAL COMPONENTS:**

**Step 13.** Inspect retrieval arm for distortion or other damage. Retrieval handle should engage into retrieval arm with ease and push button should work freely.

**Step 14.** Shift knob should rotate freely when engaging/disengaging. Pull ring on shift knob should spring back when released.

**Step 15.** Inspect retrieval mode for operation. To test, raise and lower a test weight (sand bag) of between 75 lbs. and

**Figure 17 - Reserve Lifeline**



310 lbs. Retrieval operation should be smooth and even. When the retrieval handle is released, the weight should not move and retrieval handle should stay in position (no movement). A “clicking” sound should be evident when raising load.

**Step 16.** The pawl cover (See Figure 2) must be secure and without deformation. Optional mounting bracket must be securely attached to SRL and free from defects. Detent pin must operate freely.

**5.4** If inspection reveals a defective condition, remove the SRL from service immediately and contact an authorized service center for repair.

**NOTE:** Only DBI-SALA or parties authorized in writing may make repairs to this equipment.

## **6.0 MAINTENANCE, SERVICING, STORAGE**

**6.1** Periodically clean the exterior of the SRL using water and a mild soap solution. Position the SRL so excess water can drain out. Clean labels as required.

**6.2** Clean lifeline with water and mild soap solution. Rinse and thoroughly air dry. Do not force dry with heat. An excessive buildup of dirt, paint, etc. may prevent the lifeline from fully retracting back into the housing causing a potential free fall hazard. Replace lifeline if excessive buildup is present.

**6.3** Lifeline replacement, as well as additional maintenance and servicing procedures, must be completed by an authorized service center. An authorization and return number must be issued by DBI-SALA. Do not attempt to disassemble the SRL. See section 5.1 for inspection frequency. NOTE: Do not lubricate any parts.

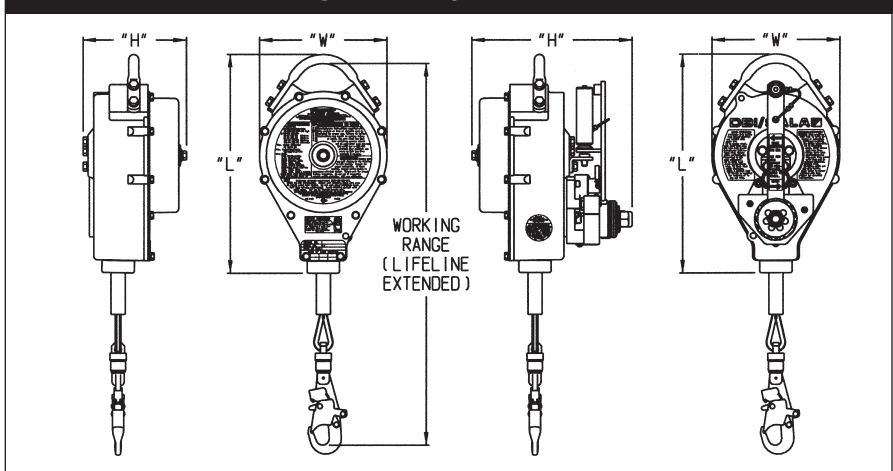
**6.4** Store SRL in a cool, dry, clean environment out of direct sunlight. Avoid areas where chemical vapors may exist. Thoroughly inspect the SRL after any period of extended storage.

## 7.0 SPECIFICATIONS

Model	Size (LxWxH) / Weight	Lifeline Type / Working Range*
3403400	13.5"x7.9"x6.4" / 29 lbs	Galvanized Wire Rope / 50 ft
3403401	13.5"x7.9"x6.4" / 29 lbs	Stainless Steel Wire Rope / 50 ft
3403402	13.5"x7.9"x9.9" / 36 lbs	Galvanized Wire Rope / 50 ft
3403403	13.5"x7.9"x9.9" / 36 lbs	Stainless Steel Wire Rope / 50 ft
3403500	16.0"x9.9"x6.7" / 44 lbs	Galvanized Wire Rope / 50 ft
3403501	16.0"x9.9"x6.7" / 44 lbs	Stainless Steel Wire Rope / 50 ft
3403502	16.0"x9.9"x10.2" / 52 lbs	Galvanized Wire Rope / 50 ft
3403503	16.0"x9.9"x10.2" / 52 lbs	Stainless Steel Wire Rope / 50 ft
3403600	18.7"x11.7"x7.2" / 60 lbs	Galvanized Wire Rope / 50 ft
3403601	18.7"x11.7"x7.2" / 60 lbs	Stainless Steel Wire Rope / 50 ft
3403602	18.7"x11.7"x10.7" / 68 lbs	Galvanized Wire Rope / 50 ft
3403603	18.7"x11.7"x10.7" / 68 lbs </td <td>Stainless Steel Wire Rope / 50 ft</td>	Stainless Steel Wire Rope / 50 ft
3403610	18.7"x11.7"x10.9" / 100 lbs	Galvanized Wire Rope / 50 ft
3403611	18.7"x11.7"x10.9" / 100 lbs	Stainless Steel Wire Rope / 50 ft
3403404	13.5"x7.9"x9.9" / 36 lbs	Spectra Synthetic Rope / 50 ft
3403405	13.5"x7.9"x6.4" / 29 lbs	Spectra Synthetic Rope / 50 ft
3403504	16.0"x9.9"x10.2" / 52 lbs	Spectra Synthetic Rope / 50 ft
3403505	16.0"x9.9"x6.7" / 44 lbs	Spectra Synthetic Rope / 50 ft
3403604	18.7"x11.7"x10.7" / 68 lbs	Spectra Synthetic Rope / 50 ft
3400311	13.5"x7.9"x9.9" / 36 lbs	Spectra Synthetic Rope / 50 ft

\* Working range includes a 2 ft. Emergency Reserve

Figure 18 - Specifications



- Maximum Arresting Force, All Models: 900 lbs. when tested in accordance with ANSI Z359.1
- Capacity, All Models: 75-310 lbs.
- Average Locking Speed, All Models: 4.5 ft./second
- Safety Factor at Rated Load: 10:1
- Housing Fastener Torques: 1/4-20 bolts: 60 in-lbs. 5/16-18 bolts: 132 in-lbs.
- U.S. Patent Numbers 4,977,647, 5,186,289 and 5,220,977. Canadian Patent Numbers 2,027,784 (hook) and 2,089,514 (indicator), European Patent Number EP0557031B7 (hook)
- SRL meets industry standards including ANSI Z359.1, and OSHA requirements.
- SRL meets CSA (Canadian Standards Association) requirements Z259.2.2

## 7.1 MATERIAL:

**Lifeline (Galvanized):** 3/16in. dia., 7x19 aircraft wire rope, 4,200 lbs. minimum tensile strength

**Lifeline (Stainless Steel):** 3/16in. dia., aircraft wire rope, 3,600 lbs. minimum 7x19 tensile strength

**Lifeline (Spectra):** 1/4in. dia., 12 strand synthetic rope, 5,600 lbs. minimum tensile strength

**Lifeline (Technora):** 1/4in. dia., 12 strand synthetic rope, 8,150 lbs. minimum tensile strength

**Cable Guide:** Nylon with Stainless Steel Guide

**Housing:** Cast Aluminum

**Cable Bumper:** Urethane

**Housing Cover:** Stainless Steel

**Anchorage Handle:** Stainless Steel

**Fasteners:** Stainless Steel

**Main Shaft:** Stainless Steel

**Locking Pawls:** Stainless Steel

**Ratchet Center:** Carbon Steel

**Motor Spring:** Carbon Spring Steel

**Finish Paint:** Polyester baked finish

**Swivel Assembly:** Stainless Steel

**Connecting Hook:** Forged Alloy Steel

## 7.2 OPERATING CHARACTERISTICS, RETRIEVAL MODELS:

Model	Gear Ratio	Weight Lifted	Cranking Force
3403402 / 3403403	6.8 : 1	200 lbs.	7 lbs - 12 lbs
		310 lbs.	11 lbs - 19 lbs
3403502 / 3403503	6.8 : 1	200 lbs.	8 lbs - 13 lbs
		310 lbs.	12 lbs - 12 lbs
3403602 / 3403603	6.8 : 1	200 lbs.	9 lbs - 12 lbs
		310 lbs.	12 lbs - 12 lbs

- Average Retrieval Rate at 60 RPM: 12.1 ft./min. (3.7 m/min.)

## 8.0 TERMINOLOGY

**AUTHORIZED PERSON:** A person assigned by the employer to perform duties at a location where the person will be exposed to a fall hazard (otherwise referred to as “user” for the purpose of these instructions).

**RESCUER:** Person or persons other than the rescue subject acting to perform an assisted rescue by operation of a rescue system.

**CERTIFIED ANCHORAGE:** An anchorage for fall arrest, positioning, restraint, or rescue systems that a qualified person certifies to be capable of supporting the potential fall forces that could be encountered during a fall or that meet the criteria for a certified anchorage prescribed in this standard.

**QUALIFIED PERSON:** A person with a recognized degree or professional certificate and with extensive knowledge, training, and experience in the fall protection and rescue field who is capable of designing, analyzing, evaluating and specifying fall protection and rescue systems to the extent required by this standard.

**COMPETENT:** One who is capable of identifying existing and predictable hazards in the surroundings or working conditions which are unsanitary, hazardous, or dangerous to employees, and who has authorization to take prompt corrective measures to eliminate them.

## 9.0 LABELING


- 9.1** These labels be securely attached to the self retracting lifeline and fully legible. See Figures 1 and 2.



RFID Label  
All Models

9.1 Labels continued . . .

		USA 3065 Pepin Avenue Red Wing, MN 55066 (800) 328-6146	CANADA 260 Export Blvd., Mississauga, Ontario, Canada L5S 1Y9 (800) 387-7484						
<b>SPECIFICATIONS</b> Capacity: Personnel/Materials 75-310 LBS (34-141 kg) Lifeline Length: 30 FT (9.1M) <table border="1" data-bbox="348 321 380 386"><tr><td> </td></tr><tr><td> </td></tr><tr><td> </td></tr></table> 55 FT (16.8 M) 80 FT (24.4 M) LENGTH <table border="1" data-bbox="348 386 380 418"><tr><td> </td></tr><tr><td> </td></tr><tr><td> </td></tr></table> FT								<b>UP ▲ WARNING/MISE EN GARDE</b> CONNECT TO ANCHORAGE Manufacturer's instructions supplied with this product at time of shipment must be followed for proper use. Failure to follow instructions may result in serious injury or death. Any unit which has seen fall arresting service should not be used after such service. Une unité qui a déjà été utilisée pour prévenir une chute ne doit pas être employée à nouveau.	
Max. Arrest Distance: 42 IN (1 M) Max. Arresting Force: 900 LBS (4.0 kN) Lifeline Rope: This model is equipped with a synthetic lifeline. See other markings for details on material, construction and use limitations. Meets OSHA, ANSI Z359.1-1992 ANSI A10.14-1991 (Type I)		<b>INSPECTION</b> Before each use inspect device in accordance with user manual including locking function (pull sharply to test), retraction function, lifeline condition, function and condition of connectors, housing and fasteners, legibility of labels, and any evidence of defects, damage, or missing parts. Inspection by competent person required at least annually, see user manual. Annual factory authorized service required in Canada. Do not use if inspection reveals unsafe condition. Not user repairable.							
<b>USE</b> Anchorage strength requirement 5000 LBS (22 kN), [5400 lbs (24 kN) Canada]. Anchor unit directly above work area to reduce swing fall hazard. Do not work above anchorage level. Full body harness recommended. Avoid lifeline contact with sharp edges. For use by trained persons only. CSA CERTIFICATION IS APPLICABLE TO THE DEVICE ONLY. CSA HAS NOT INVESTIGATED THE ANCHORAGE SYSTEM. L'INNOVIGATION EST APPLICABLE UNiquement AU DISPOSITIF. LA CSA N'A PAS EXAMINE LE SYSTEME D'ANCRAGE. CSA STANDARD Z259.2		MADE IN USA  950954 REV H							

		USA 3065 Pepin Ave. Red Wing, MN 55066 (800) 328-6146	CANADA 260 Export Blvd., Mississauga, Ontario, Canada L5S 1Y9 (800) 387-7484						
<b>SPECIFICATIONS</b> Capacity: Personnel/Materials 75-310 lbs. (34-141 kg) Max Arrest Distance: 42 in. (1 m) Max. Arresting Force: 900 lbs. (4.0 kN)		<b>UP ▲ WARNING/MISE EN GARDE</b> CONNECT TO ANCHORAGE Manufacturer's instructions supplied with this product at time of shipment must be followed for proper use. Failure to follow instructions may result in serious injury or death. Any unit which has seen fall arresting service should not be used after such service. Une unité qui a déjà été utilisée pour prévenir une chute ne doit pas être employée à nouveau.							
<b>MATERIAL:</b> <table border="1" data-bbox="181 1089 423 1154"><tr><td> </td></tr><tr><td> </td></tr><tr><td> </td></tr></table> <b>LENGTH(FT):</b> <table border="1" data-bbox="320 1089 423 1154"><tr><td> </td></tr><tr><td> </td></tr><tr><td> </td></tr></table>								<b>INSPECTION</b> Before each use inspect device in accordance with user manual including locking function (pull sharply to test), retraction function, lifeline condition, function and condition of connectors, housing and fasteners, legibility of labels, and any evidence of defects, damage, or missing parts. Inspection by competent person required at least annually, see user manual. Annual factory authorized service required in Canada. Do not use if inspection reveals unsafe condition. Not user repairable.	
Lifeline material designation: 3/16 in. (5mm) dia. 7 x 19 galvanized steel (G) or stainless steel (S). 1/4 in. dia. 12 strand technora rope (A). See other markings for details on material, construction and use limitations of rope models. Meets OSHA, ANSI Z359.1-1992 ANSI A10.14-1991 (Type I)		<b>USE</b> Anchorage strength requirement 5000 LBS (22 kN), [5400 lbs (24 kN) Canada]. Anchor unit directly above work area to reduce swing fall hazard. Do not work above anchorage level. Full body harness recommended. Avoid lifeline contact with sharp edges. For use by trained persons only. CSA CERTIFICATION IS APPLICABLE TO THE DEVICE ONLY. CSA HAS NOT INVESTIGATED THE ANCHORAGE SYSTEM. L'INNOVIGATION EST APPLICABLE UNiquement AU DISPOSITIF. LA CSA N'A PAS EXAMINE LE SYSTEME D'ANCRAGE. CSA STANDARD Z259.2							
MADE IN USA 		9509826 REV L							



9.1 Labels continued . . .

**WINCH OPERATION**

- 1) Remove grip handle from stowed position and install onto crank arm.
- 2) To engage winch, pull shift knob ring and turn knob counterclockwise then release ring. Rotate crank arm clockwise (lowering) to aid gear engagement.
- 3) To raise load, crank counterclockwise. To lower load, first crank counterclockwise to release fall arrest brake, then crank clockwise.

**NOTE:** A minimum load of 75 LBS (33 N) is required for lowering or to pay out line. A force of 30 LBS (13.3 N) is required to operate winch when loaded to capacity.

**9503129 REV B**

**OPERATION (CONTINUED)**

**CAUTION:** Stop cranking when line is fully extended or retracted. Continued cranking can damage components.

- 4) To disengage winch, first remove load from line. Rotate shift knob counterclockwise. Pull ring until knob can be rotated clockwise to locked position. Release ring.
- 5) Restow crank arm and grip handle.

**WARNING:** Avoid slack line while in rescue mode.

**NOTE:** Refer to manual supplied with this product for detailed instructions.

**9503130 REV A**


DBI/SALA  
3965 PEPIN AVE.  
RED WING, MN 55066-1837  
(800) 328-6146

---

**▲ WARNING**

THIS HANDLE INCORPORATES A TORQUE LIMITER TO PREVENT OVERLOADING. RAISING OR LOWERING LOADS IN EXCESS OF THE RATED CAPACITY (310 LBS) WILL RESULT IN SLIPPAGE OF THE HANDLE.

**TO  
ENGAGE  
DRIVE**




**RAISE**

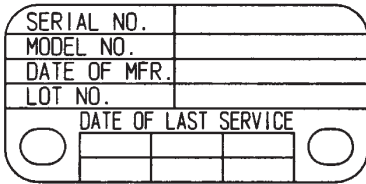
**CAPACITY  
310 LBS**

**NOT FOR  
WORK  
SUPPORT  
OR POSI-  
TIONING.  
REFER TO  
MANUAL.**

**LOWER**



9.1 Labels continued . . .



Identification Label  
All Models



Impact Indicator Label  
All Models



Swivel Hook Label  
All Models

Lifeline Specifications Material: Spectra Construction: 12 strand Size: 1/4 in. diameter Heat resistant to 140° F (60° C) 9503625	<b>▲ WARNING</b>
	Do not tie or knot lifeline. Dirt, contaminants, and water can lower dielectric properties of lifeline, use caution near energized lines. Avoid lifeline contact with sharp or abrasive surfaces. Inspect line frequently for cuts, fraying, burns, or signs of chemical damage. See user manual for more information. Failure to heed these warnings may result in injury or death.

Warning Label  
Spectra Synthetic Rope Models

Lifeline Specifications Material: Technora Construction: 12 strand Size: 1/4 in. diameter Heat resistant to 900° F (480° C) 9508832	<b>▲ WARNING</b>
	Do not tie or knot lifeline. Dirt, contaminants, and water can lower dielectric properties of lifeline, use caution near energized lines. Avoid lifeline contact with sharp or abrasive surfaces. Inspect line frequently for cuts, fraying, burns, or signs of chemical damage. See user manual for more information. Failure to heed these warnings may result in injury or death.

Warning Label  
Technora Synthetic Rope Models

**WARNING    WARNING    WARNING    WARNING**  
**DISCONTINUE USE IMMEDIATELY! RESERVE LIFELINE IS DEPLOYED,**  
**RETURN FOR FACTORY SERVICE DB INDUSTRIES INC., 3833 SALA WAY,**  
**RED WING, MN 55066 PHONE 651-388-8282 OR 1-800-328-6146**

Reserve Lifeline Warning Label  
Spectra and Technora Synthetic Rope Models



## WARRANTY

Equipment offered by DBI-SALA is warranted against factory defects in workmanship and materials for a period of two years from date of installation or use by the owner, provided that this period shall not exceed two years from date of shipment. Upon notice in writing, DBI-SALA will promptly repair or replace all defective items. DBI-SALA reserves the right to elect to have any defective item returned to its plant for inspection before making a repair or replacement. This warranty does not cover equipment damages resulting from abuse, damage in transit, or other damage beyond the control of DBI-SALA. This warranty applies only to the original purchaser and is the only one applicable to our products, and is in lieu of all other warranties, expressed or implied.

This instruction applies to the following models:

3400001	3400205	3400406	3400610	3403501
3400002	3400206	3400407	3400611	3403502
3400006	3400207	3400501	3400612	3403503
3400007	3400208	3400502	3400613	3403504
3400008	3400301	3400506	3400620	3403505
3400101	3400302	3400507	3400621	3403506
3400102	3400307	3400508	3401255	3403507
3400107	3400308	3400509	3403400	3403600
3400108	3400309	3400510	3403401	3403601
3400109	3400311	3400511	3403402	3403602
3400113	3400312	3400512	3403403	3403603
3400114	3400316	3400516	3403404	3403604
3400115	3400317	3400517	3403405	3407626
3400201	3400401	3400518	3403406	
3400202	3400402	3400519	3403500	

Additional model numbers may appear on the next printing of these instructions.



A CAPITAL SAFETY COMPANY

USA

3833 SALA Way  
Red Wing, MN 55066-1837  
Toll Free: 800-328-6146  
Phone: (651) 388-8282  
Fax: (651) 388-5065  
[www.capitalsafety.com](http://www.capitalsafety.com)

Canada

260 Export Boulevard  
Mississauga, Ontario L5S 1Y9  
Toll Free: 800-387-7484  
Phone: (905) 795-9333  
Fax: (905) 795-8777  
[www.capitalsafety.com](http://www.capitalsafety.com)

This manual is available for download at [www.capitalsafety.com](http://www.capitalsafety.com).



Certificate No. FM 39709

Form: 5902122  
Rev: H