

# MeshGuard User's Guide



**TTT Environmental**  
Instruments and Supplies

*The preferred source for instrument  
Rentals, Sales, Service and Supplies!*

4201 B Street  
Anchorage, AK 99503  
(907) 770-9041

[www.tttenviro.com](http://www.tttenviro.com)

25420 74<sup>th</sup> Avenue S.  
Kent, WA 98032  
(253) 373-9041

[info@tttenviro.com](mailto:info@tttenviro.com)



Rev. F  
October 2011  
P/N D01-4002-000



# MeshGuard User's Guide

---

## Contents

1	Standard Kit .....	6
2	General Information.....	6
3	Physical Description .....	8
	3.1 LCD Display .....	9
	3.2 Specifications.....	10
4	Operating The MeshGuard .....	11
	4.1 Turning The MeshGuard On.....	11
	4.2 Turning The MeshGuard Off.....	12
	4.3 Low Battery Indicator & Action .....	13
	4.4 Wireless Communication Indicator .....	13
5	Operation Modes.....	14
	5.1 Detection Mode.....	15
	5.2 Manually Sending Data.....	16
	5.3 Detection Mode (When Portable Mode Is Enabled) ....	17
	5.4 Programming Mode .....	19
	5.4.1 Entering Programming Mode .....	20
	5.4.2 Exiting Programming Mode .....	21
	5.4.3 Zero Calibration .....	22
	5.4.4 Span Calibration.....	23
	5.4.5 Change High Alarm .....	26
	5.4.6 Change Low Alarm.....	27
	5.4.7 Change STEL setting (Portable Mode Only).....	28
	5.4.8 Change TWA setting (Portable Mode Only) .....	29
	5.4.9 Change SPAN value .....	30
	5.4.10 Change Pan ID .....	31
	5.4.11 Join Mesh Network .....	31
	5.4.12 Change Communication Interval .....	31
6	Diagnostic Mode.....	32
	6.1 Entering Diagnostic Mode .....	32
	6.2 Exiting Diagnostic Mode .....	33
	6.3 Diagnostic Mode Readings .....	33
	6.3.1 Sensor Raw Count.....	33
	6.3.2 Battery Raw Count.....	33
	6.3.3 Temperature Raw Count .....	33
	6.3.4 Sudden Power Off Count .....	33

# MeshGuard User's Guide

---

6.3.5	Zero Raw Count.....	34
6.3.6	Calibration Delta Counts.....	34
6.4	Diagnostic Mode Programming.....	34
6.4.1	Fixed Or Portable Operation Selection.....	36
6.4.2	Radio Enable/Disable.....	36
6.4.3	Std Enable or Rtr Enable.....	37
6.4.4	Factory Setting.....	37
6.4.5	Audible & Visible Alarm Enable/Disable.....	37
7	Sensor And Battery Replacement.....	38
7.1	Battery replacement.....	38
7.2	Proper Battery Disposal.....	39
7.3	Sensor Filter Replacement.....	40
7.4	Sensor Replacement.....	41
8	Troubleshooting.....	42
9	Alarm Signal Summary.....	43
10	Appendix A: Installation.....	45
10.1	Magnet-Mount Installation.....	45
10.2	Fixed Installation.....	46
10.3	Magnetic Mount Alternative Installation.....	49
11	MeshGuard Sensor Specifications.....	50

# MeshGuard User's Guide

## WARNINGS

### Read Before Operating

This manual must be carefully read by all individuals who have or will have the responsibility of using, maintaining, or servicing this product. The product will perform as designed only if it is used, maintained, and serviced in accordance with the manufacturer's instructions.

### FCC Part 15 statement and CE

This device complies with Part 15 of the FCC rules. Operation is subject to the following two conditions: (1) This device may not cause harmful interference, and (2) this device must accept any interference received, including interference that may cause undesired operation.

### Warning

Use only the Lithium battery or external rechargeable battery provided by RAE Systems. This instrument has not been tested in an explosive gas/air atmosphere having an oxygen concentration greater than 21%. Substitution of components may impair suitability for intrinsic safety. Replace batteries only in non-hazardous locations.

**STATIC HAZARD:** Clean only with a damp cloth.

For safety reasons this equipment must be operated and serviced by qualified personnel only. Read and understand instruction manual completely before operating or servicing. Any rapid up-scale reading followed by a declining or erratic reading may indicate a gas concentration beyond upper scale limit, which may be hazardous.

### Intrinsically Safe Marking



Cl. I, Div. 1, Gr A, B, C, D T4

$-40^{\circ}\text{C} \leq T_{amb} \leq 50^{\circ}\text{C}$

IECEX TSA 07.0032X Ex ia I/IIC T4



0575  IM1/II 1G Ex ia I/IIC T4

DNV-2007-OSL-ATEX 8958X

$U_i = 3.6\text{V}$ ,  $C_i = 63\mu\text{F}$ ,  $L_i/R_i = 3.5\mu\text{H}/\text{ohm}$

# MeshGuard User's Guide

---

## 1 Standard Kit

Monitor with antenna  
User's Guide  
CD with resources  
Maintenance tool  
Calibration certificate  
Calibration adapter

## 2 General Information

MeshGuard (FTD-2000) is a single toxic gas detector integrated with a wireless mesh network-enabled transmission radio module. It can work as a fixed device or as a portable device. The detector has the option of relaying the wireless signal to other MeshGuards as needed, to bypass obstacles. The MeshGuard's built-in radio board operates on a frequency of 2.4GHz and complies with IEEE 802.15.4 standard. The FTD-2000 works with the FMC-2000 wireless controller on a flexible, robust wireless network to provide reliable, low-cost operation. It also works in a ProRAE.net network with a PC, and it supports point-to-point and point-to-multi-point networks.

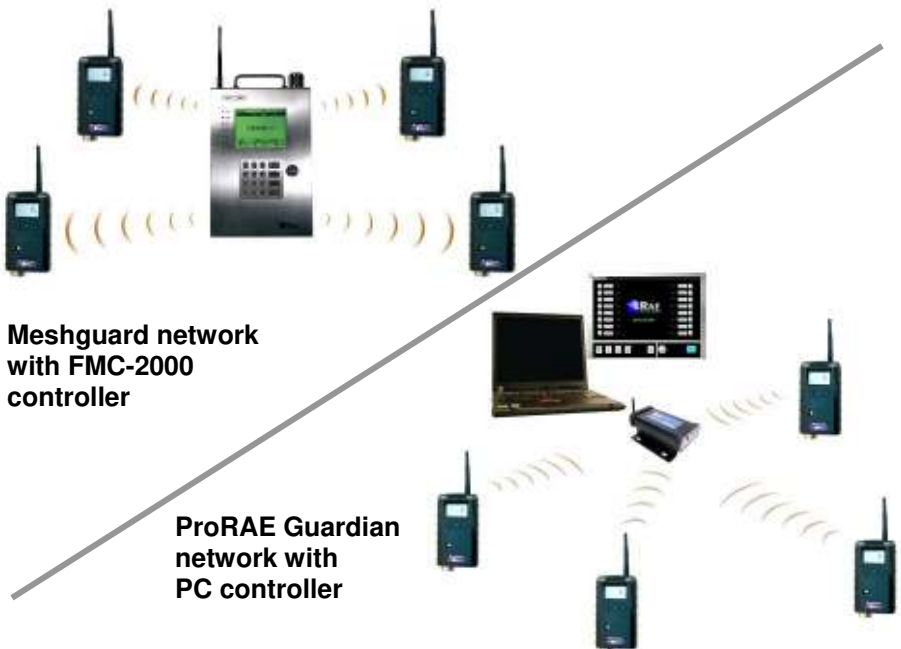

# MeshGuard User's Guide

---

## Key Features

- Up to 6 months continuous operation
- IEEE 802.15.4 Mesh network functionality with 64-bit encryption
- Robust wireless mesh network with auto network forming and configuration
- Operating distance: up to 300 m, line of sight
- Very low-cost installation – no hardwiring involved
- Large area coverage with multi-hop mesh network
- Field-replaceable battery
- Loud audio alarm, 90dB @ 30cm (12")
- Large, easy-to-read continuous display
- Bright red flashing alarm
- Highly resistant to RFI interference
- IP-65 rated for outdoor use in harsh environments
- Sensors supported: See section 14, "MeshGuard Sensor Specifications"
- Field-replaceable sensor.
- Large, easy-to-read continuous display of gas concentration in ppm
- User-adjustable high and low alarms
- User-adjustable STEL and TWA alarms (in portable mode)
- Simple calibration

# MeshGuard User's Guide

## 3 Physical Description



1	LED alarm
2	LCD
3	Buzzer alarm
4	Sensor gas inlet
5	Battery cover (on bottom)
6	Y/+, MODE, and N/- keys
7	Antenna
Not visible	Optional magnetic mount on rear



# MeshGuard User's Guide

## 3.1 LCD Display

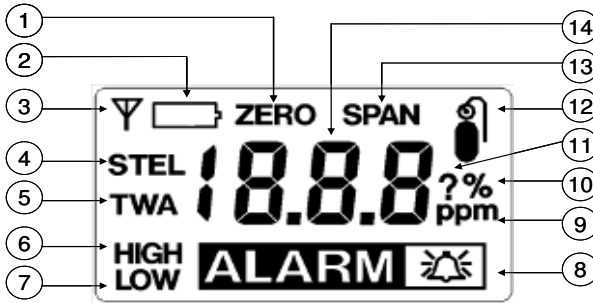

1*	Zero Calibration
2	Low Battery Indicator
3	Wireless Communication (if on, the monitor is in STD; if blinking, the monitor is RTR)
4*	Short Term Exposure Limit (STEL)
5*	Time Weighted Average (TWA)
6, 8*	High Alarm
7, 8*	Low Alarm
9*	Gas Concentration unit, ppm
10*	Gas Concentration unit, %
11	Save Setting
12,13*	Span Calibration
14	Reading Value
Remark:	Concentration unit is shown as either ppm (9) or % (10).

# MeshGuard User's Guide

## 3.2 Specifications

<b>RF Certifications</b>	FCC Part15 CE EN 300328 SRRC(Pending)
<b>Display</b>	Customized LCD (1 x 1.5") with backlight
<b>Audible alarm</b>	90dB @ 30cm
<b>Visual alarm</b>	2 super-bright red LEDs
<b>Calibration</b>	Two-point field calibration
<b>RF</b>	IEEE 802.15.4/Zigbee with mesh stack
<b>Operating Range</b>	Up to 300 meters, line of sight
<b>Transmission Power</b>	Up to 18dBm (63mw EIRP)
<b>Receiver Sensitivity</b>	Minimum -95dBm at 2.4GHz
<b>User Interface</b>	Three keys (Y/+, MODE, N/-)
<b>Power Supply</b>	D-size EVE or Xeno Lithium primary battery, +3.6V, 19 Ah
<b>Max Current Consumption</b>	200mA@3.6V during transmission <0.5mA@3.6V during standby
<b>Operation Time</b>	Internal Battery: For STD* Mode: up to 6 Months For RTR** Mode: up to 10 days *STD is standard-function device **RTR is router-function device
<b>Operating Temperature</b>	-40° to 122° F (-40° to +50° C) for CO, and H <sub>2</sub> S sensors Other sensors: -4° to 122° F (-20° to +50° C)
<b>Humidity</b>	0% to 95% relative humidity, non-condensing
<b>Dimensions</b>	26.5cm x 9.5cm x 5.5cm (10.5" L x 3.7" W x 2.1" H)
<b>Weight</b>	0.6 kg (1.3 lbs)
<b>Package</b>	IP-65
<b>Mounting</b>	Optional stainless-steel bracket mount or magnetic mount

## Operation

### 4 Operating The MeshGuard

Make sure the battery is installed before operating the MeshGuard. Refer to page 38 for information on battery installation and replacement.

#### 4.1 Turning The MeshGuard On

Hold down the [MODE] key and release it when the MeshGuard beeps. The monitor is now on, as indicated by the display:



The MeshGuard performs a self-test, followed by warm-up and zero calibration. The display briefly shows the firmware version (for example, "F1.0" means firmware version 1.0, "F2.0" means firmware version 2.0, etc.):



Then the MeshGuard initializes the wireless network and displays this information:



Note: If MeshGuard is unable to find a radio network to connect with, it searches, and the display alternates between "rdo" and "Srh" (for "radio search").

# MeshGuard User's Guide

Next, the display tells you that MeshGuard is initiating network communication:



Next, if a network is located, an antenna icon appears (if no network is found, then the icon is not shown; press [Y/+] to search for a network). The current gas concentration reading is also displayed:



**Note:** When adding a MeshGuard detector to a new network for the first time, it is recommended that you press [Y/+] to manually initiate a search for the network.

The MeshGuard is now operational.

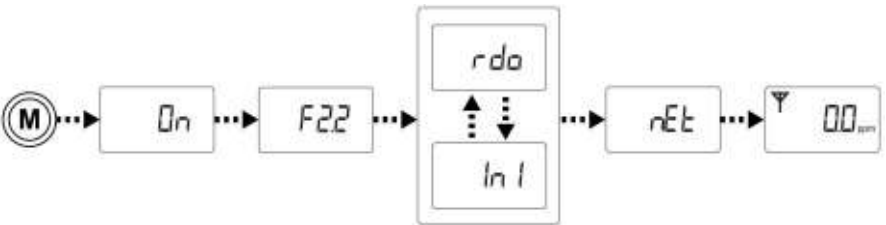

## 4.2 Turning The MeshGuard Off

Hold down the [MODE] key through the “5...4...3... 2... 1... oFF” sequence. The monitor is off when the display is blank. Release the [MODE] key.



The MeshGuard is now off.

## MeshGuard User's Guide

---

### 4.3 Low Battery Indicator & Action

The MeshGuard's battery is designed for up to six months' life in STD mode (in RTR mode, including the MeshGuard Router's normal operation, battery life is up to 10 days). When the battery gets low, the MeshGuard beeps once per minute and an empty battery icon appears. It is recommended that the battery be changed immediately, to minimize disruption.



When the battery is completely depleted, the LCD displays "OFF," and the LED, buzzer and vibration alarm activate once per second. The battery icon also blinks on and off. The MeshGuard shuts down after you press any key, or shuts down automatically if you do not press a key for 60 seconds.

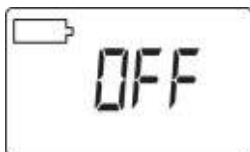

### 4.4 Wireless Communication Indicator

When wireless communication is turned on, the LCD displays the wireless link status in the upper left corner:



If the MeshGuard finds and joins a wireless network, an antenna icon is shown in the display. If no link or a weak link is established, no antenna icon is shown. Press [Y/+] to search for a network.

A flashing antenna means the MeshGuard is in Router Mode (RTR), and the radio is always on.

# MeshGuard User's Guide

---

## 5 Operation Modes

The MeshGuard can operate as a standard (STD) or a router-mode (RTR) device. In STD mode, the MeshGuard transmits data to the host at a set interval (the default is 30 seconds) or anytime an alarm occurs. In RTR mode, the MeshGuard receives data in real time, and it can also work as a router as needed to relay data from STD devices back to the host.

**Note:** Operating the MeshGuard in RTR mode reduces battery life. The interval can be changed in Programming Mode. See page 19 for details.

In addition, there is a Detection Mode for standard operation, Programming Mode for making changes to values (such as the High Alarm, etc.), Diagnostic Mode (for servicing and checking the sensor, etc.), and Diagnostic Programming Mode, which is for selecting between STD & RTR modes, etc.

# MeshGuard User's Guide

## 5.1 Detection Mode

The MeshGuard can operate in fixed or portable mode. Whenever you start MeshGuard, it is automatically in fixed Detection Mode, which is the default.

The MeshGuard displays the current reading:



Pressing [MODE] steps through the Detection Mode screens:

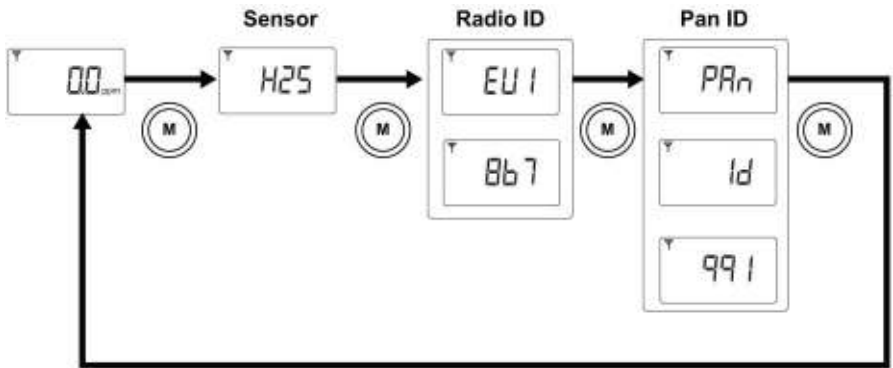

Press [MODE], and it displays the sensor type:



## MeshGuard User's Guide

---

Press [MODE], and it alternates between EUI (Extended Unique Identifier) and its value:



Press [MODE], and it alternates between Pan and ID (Personal Area Network Identifier) and its value:



Press [MODE] to return to the detector reading:



## 5.2 Manually Sending Data

While the MeshGuard typically sends reading data to the network on a fixed interval, you can send the data anytime.

Press the [Y/+] key. The screen alternates between "InI" and "nEt" one time, sends the current sensor data, and returns to the detector reading.

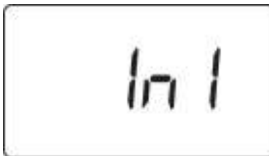



# MeshGuard User's Guide

## 5.3 Detection Mode (When Portable Mode Is Enabled)

When Portable Mode is enabled (see page 21), pressing [MODE] steps through three more screens, STEL, TWA, and Peak:

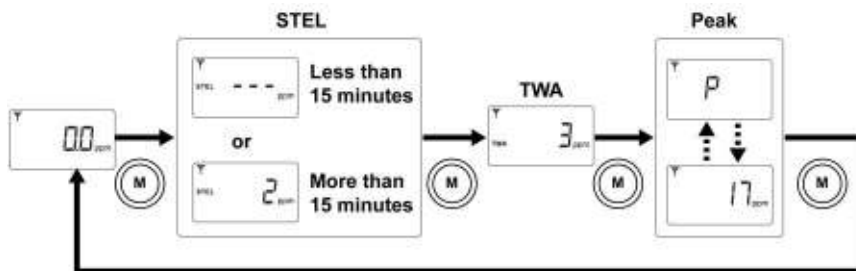

The initial screen is the reading display:



Press [MODE], and it displays STEL. The STEL (short-term exposure limit) is the average reading of the gas concentration for the last 15 minutes.

**Note:** The STEL reading does not appear until 15 minutes have elapsed. If the MeshGuard has not been on for 15 minutes, it displays three dashes:

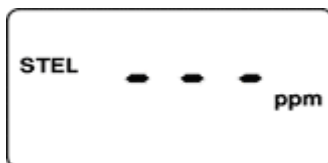

## MeshGuard User's Guide

---

Press [MODE], and it displays TWA. The TWA (time-weighted average) is the accumulated reading of the gas concentration, divided by 8 hours, since the monitor was turned on.



Press [MODE], and the display indicates the Peak reading by alternating between "P" (for "Peak") and a numerical value:

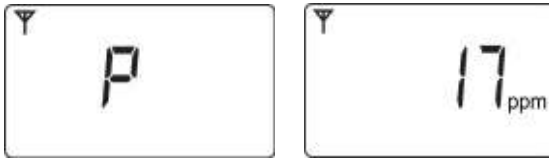

Press [MODE] to return to the current reading:



# MeshGuard User's Guide

---

## 5.4 Programming Mode

Programming Mode allows you to perform any of the following actions (listed in order of appearance):

- Calibrate the MeshGuard
- Changing Preset Limits or Span Gas Values
- Set Pan ID
- Join network
- Choose communication interval

The menus accessed in Programming Mode are:

- Zero Calibration
- Span Calibration
- High Alarm
- Low Alarm
- STEL (Portable Mode only)
- TWA (Portable Mode only)
- Set Span Value
- Pan ID
- Join Network
- Communication interval

# MeshGuard User's Guide

## 5.4.1 Entering Programming Mode

To enter the Programming Mode, press [MODE] and [N/-] for 3 seconds. “Pro” appears in the display:

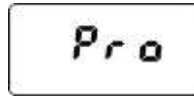

Pressing [N/-] steps you through all the screens and then returns to the first programming display:

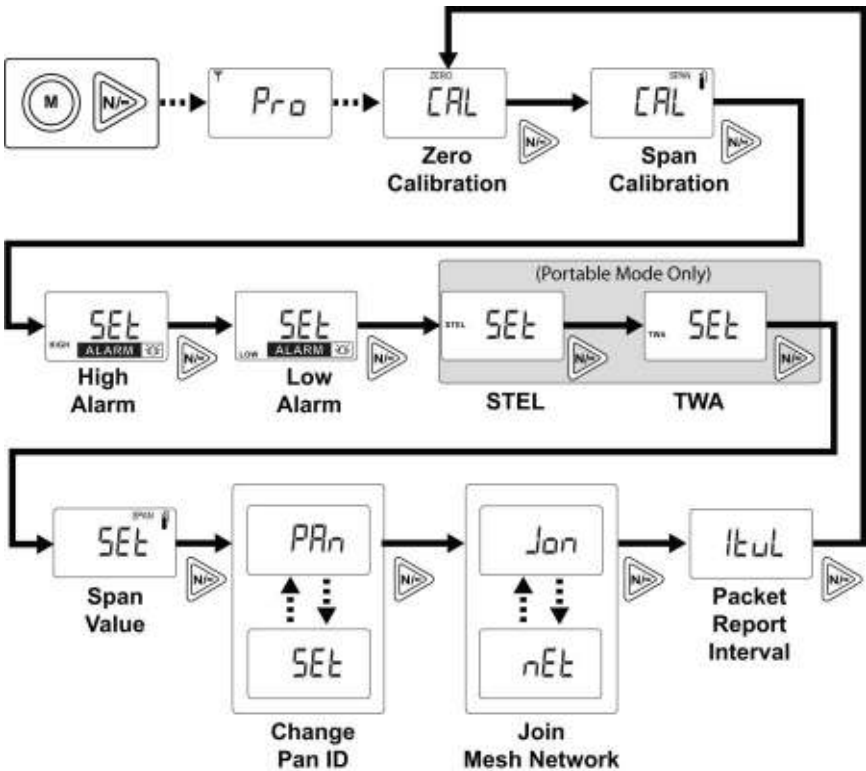

Each display alternates between its name and a status message or value.

**Note:** You can exit Programming Mode at any time by pressing [MODE]. Also, if you do not make a change within one minute, the MeshGuard exits Programming Mode and returns to Detection Mode.

# MeshGuard User's Guide

---

Settings can be changed as follows:

1. When a menu is selected, it flashes between two screens. For example:



2. Press [MODE] to exit Program Mode and return to Detection Mode, or press [N/-] to advance to the next menu.

3. Press [Y/+] to enter. The LCD displays “go.”

## 5.4.2 Exiting Programming Mode

You may exit Programming Mode anytime and return to Detection Mode in either of these two ways:

- Press [MODE]. MeshGuard exits Program Mode and shows the current reading in Detection Mode.
- Do not press any buttons for 1 minute. MeshGuard automatically exits Programming Mode and returns to Detection Mode, showing the current reading.



# MeshGuard User's Guide

## 5.4.3 Zero Calibration

When “CAL” and “go” are displayed in alternation, and “ZERO” is shown, the MeshGuard is ready to perform a zero calibration.

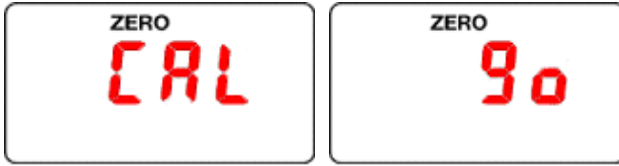

Press [Y/+]. The LCD displays “go.”



The display counts down from 10 to 0.



After the countdown reaches 0, the LCD displays “dn,” for “done.” The reading should show 0 (zero). Otherwise, repeat the zero calibration.



## MeshGuard User's Guide

---

**Note:** To stop zero calibration before the countdown reaches 0, press any key. The LCD displays “no” and advances to the next programming menu, Span calibration.



### 5.4.4 Span Calibration

“CAL” and “go” flash in alternation, and “SPAN” is shown. The MeshGuard is now ready to perform a span calibration.



To start calibration, press [Y/+]. The LCD displays “go.”



The MeshGuard waits for 10 seconds so that you have time to connect the span gas. Connect the calibration gas adapter to the MeshGuard, and connect the gas cylinder to the adapter. Start the flow of gas.

## MeshGuard User's Guide

---

When the gas flow starts, the LCD displays “gAS” and the span concentration value.

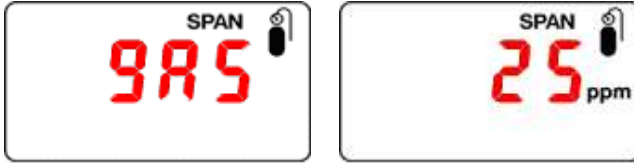

The MeshGuard now counts down to 0.

**Note:** The countdown time varies according to the type of sensor used in the MeshGuard.



After counting down and reaching 0, the LCD displays “dn.” The reading should be the span concentration value. Otherwise, the span calibration should be repeated.

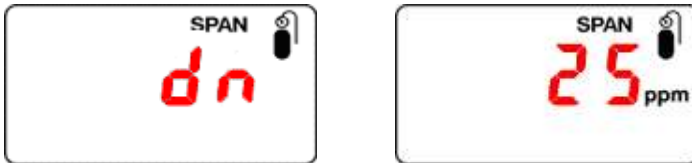



## MeshGuard User's Guide

---

If the MeshGuard does not detect gas after counting down to 0, the LCD displays “Err” (for “error”). The LED glows red and the buzzer sounds to provide extra warning. The MeshGuard automatically returns to the span calibration display.



**Note:** To stop span calibration before the countdown reaches 0, press any key. The LCD displays “no” and advances to the next programming menu, Change High Alarm.

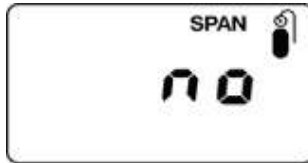

# MeshGuard User's Guide

## 5.4.5 Change High Alarm

At the menu for changing the High Alarm setting, “Set” and “ go” flash in alternation, and both “HIGH” and “ALARM” are shown.

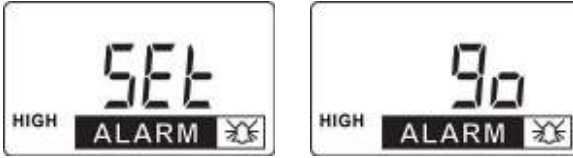

Press [Y/+] to enter and change the setting. Press [MODE] to go back to Detection Mode or [N] to advance to the next menu.

The LCD displays the current value. Change the value if necessary.



To change the value:

1. Press [Y/+] to increase the number and [N/-] to decrease it.
2. Press [MODE] to advance to the next digit.
3. After moving to the last digit and making changes, press [MODE]. A question mark (?) is shown in the display, asking if you want to save the change.
  - Press [Y/+] for yes. The message “dn” means the change is done.
  - Press [N/-] for no. A “no” message means that the change was abandoned.
  - Press [MODE] to return to the first digit.

# MeshGuard User's Guide

## 5.4.6 Change Low Alarm

At the Change Low Alarm menu, “Set” and “go” flash in alternation, and “LOW” and “ALARM” are visible in the display.

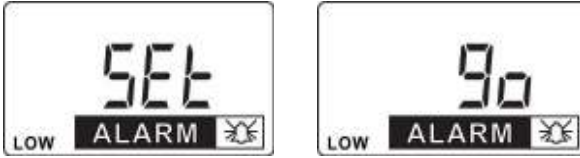

Press [Y/+] to enter and change the setting. Press [MODE] to exit and return to Detection Mode or [N] to advance to the next menu.

The LCD displays current value. Change the value if necessary.



To change the value:

1. Press [Y/+] to increase the number and [N/-] to decrease it.
2. Press [MODE] to advance to the next digit.
3. After moving to the last digit and making changes, press [MODE]. A question mark (?) is shown in the display, asking if you want to save the change.
  - Press [Y/+] for yes. The message “dn” means the change is done.
  - Press [N/-] for no. A “no” message means that the change was abandoned.
  - Press [MODE] to return to the first digit.

## MeshGuard User's Guide

### 5.4.7 Change STEL setting (Portable Mode Only)

**Note:** This menu is only available when the MeshGuard is in Portable Mode. If it is in Fixed Mode, you will not see this menu and cannot change its settings.

“Set” and “go” flash in alternation, and “STEL” is shown.



Press [Y/+] to enter and change the setting, [MODE] to exit and return to Detection Mode, or [N/-] to advance to the next menu.

The LCD displays current value. Change the value if necessary.



To change the value:

1. Press [Y/+] to increase the number and [N/-] to decrease it.
2. Press [MODE] to advance to the next digit.
3. After moving to the last digit and making changes, press [MODE]. A question mark (?) is shown in the display, asking if you want to save the change.
  - Press [Y/+] for yes. The message “dn” means the change is done.
  - Press [N/-] for no. A “no” message means that the change was abandoned.
  - Press [MODE] to return to the first digit.

# MeshGuard User's Guide

## 5.4.8 Change TWA setting (Portable Mode Only)

**Note:** This menu is only available when the MeshGuard is in Portable Mode. If it is in Fixed Mode, you will not see this menu and cannot change its settings.

“Set” and “go” flash in alternation, and “TWA” is shown.

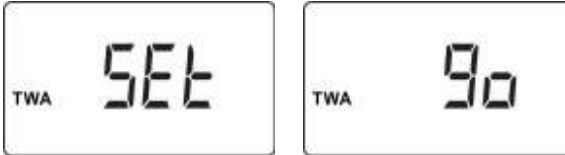

Press [Y/+] to enter and change the setting, [MODE] to exit and return to Detection Mode, or [N/-] to advance to the next menu.

The LCD displays the current value. Change the value if necessary.



To change the value:

1. Press [Y/+] to increase the number and [N/-] to decrease it.
2. Press [MODE] to advance to the next digit.
3. After moving to the last digit and making changes, press [MODE]. A question mark (?) is shown in the display, asking if you want to save the change.
  - Press [Y/+] for yes. The message “dn” means the change is done.
  - Press [N/-] for no. A “no” message means that the change was abandoned.
  - Press [MODE] to return to the first digit.

# MeshGuard User's Guide

## 5.4.9 Change SPAN value

“Set” and “go” flash in alternation, and “SPAN” and a gas cylinder icon are shown.

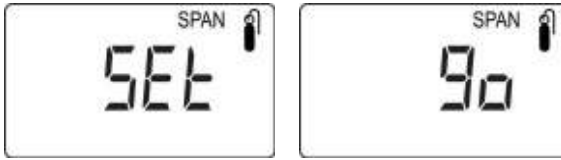

Press [Y/+] to enter and change the setting, [MODE] to exit and return to Detection Mode, or [N/-] to advance to the next menu.

The LCD displays the current value. Change the value if necessary.



To change the value:

1. Press [Y/+] to increase the number and [N/-] to decrease it.
2. Press [MODE] to advance to the next digit.
3. After moving to the last digit and making changes, press [MODE]. A question mark (?) is shown in the display, asking if you want to save the change.
  - Press [Y/+] for yes. The message “dn” means the change is done.
  - Press [N/-] for no. A “no” message means that the change was abandoned.
  - Press [MODE] to return to the first digit.

# MeshGuard User's Guide

---

## 5.4.10 Change Pan ID

Press Y/+ to enter the menu to make changes to the value.

1. Press [Y/+] to increase the number and [N/-] to decrease it.
2. Press [MODE] to advance to the next digit.
3. After moving to the last digit and making changes, press [MODE]. A question mark (?) is shown in the display, asking if you want to save the change.
  - Press [Y/+] for yes. The message “dn” means the change is done.
  - Press [N/-] for no. A “no” message means that the change was abandoned.
  - Press [MODE] to return to the first digit.

## 5.4.11 Join Mesh Network

Press [Y/-] to initiate joining a network. Three bars flash in sequence while it searches. When it is done, it alarms once and displays “dn” for “done.”

## 5.4.12 Change Communication Interval

This menu allows you to change the interval between wireless transmissions. “SET” and “ItUL” flash, to indicate that you can change the interval. The interval can be set to 10, 30, 60, 300, or 600 seconds.

**Note:** The default interval is 30 seconds.

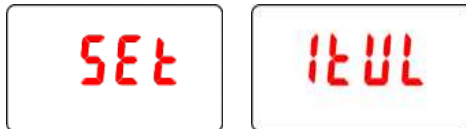

Press [Y/+] to enter and change the setting, [MODE] to exit and return to Detection Mode, or [N/-] to advance to the next MENU.



## 6 Diagnostic Mode

Diagnostic Mode provides raw data from sensors and about settings.

### 6.1 Entering Diagnostic Mode

**Note:** To enter Diagnostic Mode, you must begin with the MeshGuard turned off.

Press and hold [Y/+] and [MODE] until the MeshGuard starts.

The instrument goes through a brief startup, and then displays “dIA” to indicate it is in Diagnostic Mode. It then switches to showing raw data for the sensor (the display shows “rAU” followed by a number).

The following chart shows how to navigate Diagnostic Mode (pressing N/- repeatedly steps through the screens):

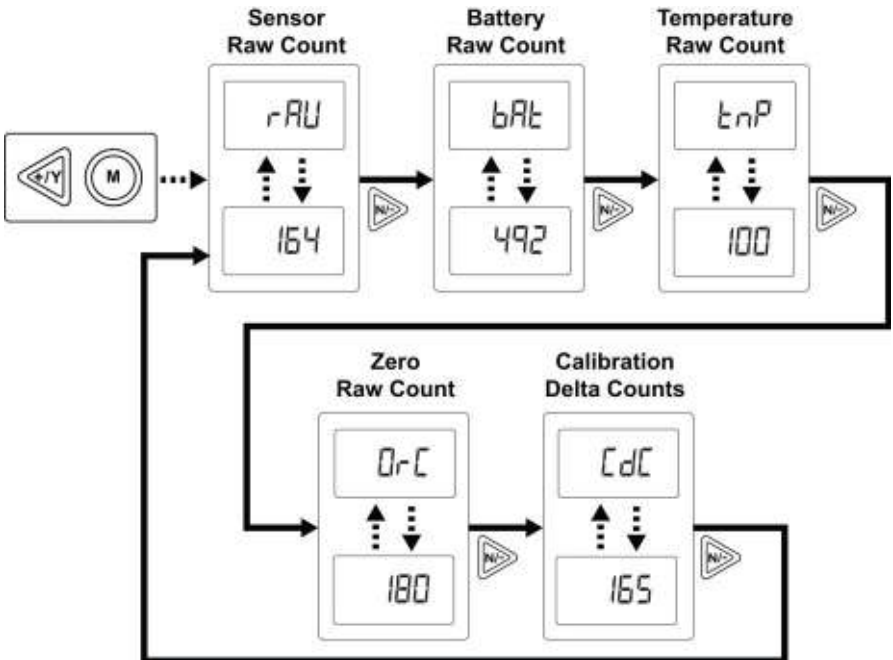



# MeshGuard User's Guide

---

## 6.2 Exiting Diagnostic Mode

**Note:** You can exit Diagnostic Mode and enter Programming Mode and calibrate the MeshGuard as usual by pressing both [MODE] and [N/-] for three seconds.

**Note:** You can exit Diagnostic Mode and enter Detection Mode by pressing [MODE] and [Y/+] together for three seconds, or by turning it off and on again.

## 6.3 Diagnostic Mode Readings

In Diagnostic mode, you can step through readings by pressing [N/-].

### 6.3.1 Sensor Raw Count

Sensor Raw Count is indicated by “rAU” followed by a number.

- Press [N/-] to advance to the next reading.
- Press [MODE] and [Y/+] together for three seconds to exit Diagnostic Mode and enter Detection Mode.

### 6.3.2 Battery Raw Count

Battery Raw Count is indicated by “bAt” followed by a number.

- Press [N/-] to advance to the next reading.
- Press [MODE] and [Y/+] together for three seconds to exit Diagnostic Mode and enter Detection Mode.

### 6.3.3 Temperature Raw Count

Temperature Raw Count is indicated by “tNp” followed by a number.

- Press [N/-] to advance to the next reading.
- Press [MODE] and [Y/+] together for three seconds to exit Diagnostic Mode and enter Detection Mode.

### 6.3.4 Sudden Power Off Count

Sudden Power-Off Count is indicated by “rSt” followed by a number.

# MeshGuard User's Guide

---

- Press [N/-] to advance to the next reading.
- Press [MODE] and [Y/+] together for three seconds to exit Diagnostic Mode and enter Detection Mode.

## 6.3.5 Zero Raw Count

Zero Raw Count is indicated by “0rC” followed by a number.

- Press [N/-] to advance to the next reading.
- Press [MODE] and [Y/+] together for three seconds to exit Diagnostic Mode and enter Detection Mode.

## 6.3.6 Calibration Delta Counts

Calibration Delta CTS is indicated by “CdC” followed by a number.

- Press [N/-] to return to the first raw count.
- Press [MODE] and [Y/+] together for three seconds to exit Diagnostic Mode and enter Detection Mode.

## 6.4 Diagnostic Mode Programming

You can enter a special programming mode from Diagnostic Mode in order to perform advanced programming functions. These include:

- Enable Portable Mode
- Enable Radio
- Enable STD or RTR
- Return MeshGuard to original factory settings
- Enable/disable audible and visible alarms

**Note:** When the MeshGuard is in this programming mode, if you do not make a change or press a key for 60 seconds, it reverts to the standard Diagnostic Mode.

**Important!** After you make changes in Diagnostic Mode, it is recommended that you turn off the MeshGuard and turn it on again before using it.

# MeshGuard User's Guide

Enter this programming mode by first entering Diagnostic Mode. This requires starting the MeshGuard while holding [Y/+] and [MODE]. When you see the Sensor Raw Count screen, hold [MODE] and N/- until you see "Pro" in the display, indicating that you are in Programming Mode.

Step through the menus by pressing [N/-]. Exit by pressing [MODE], and then shutting off the MeshGuard and restarting it.

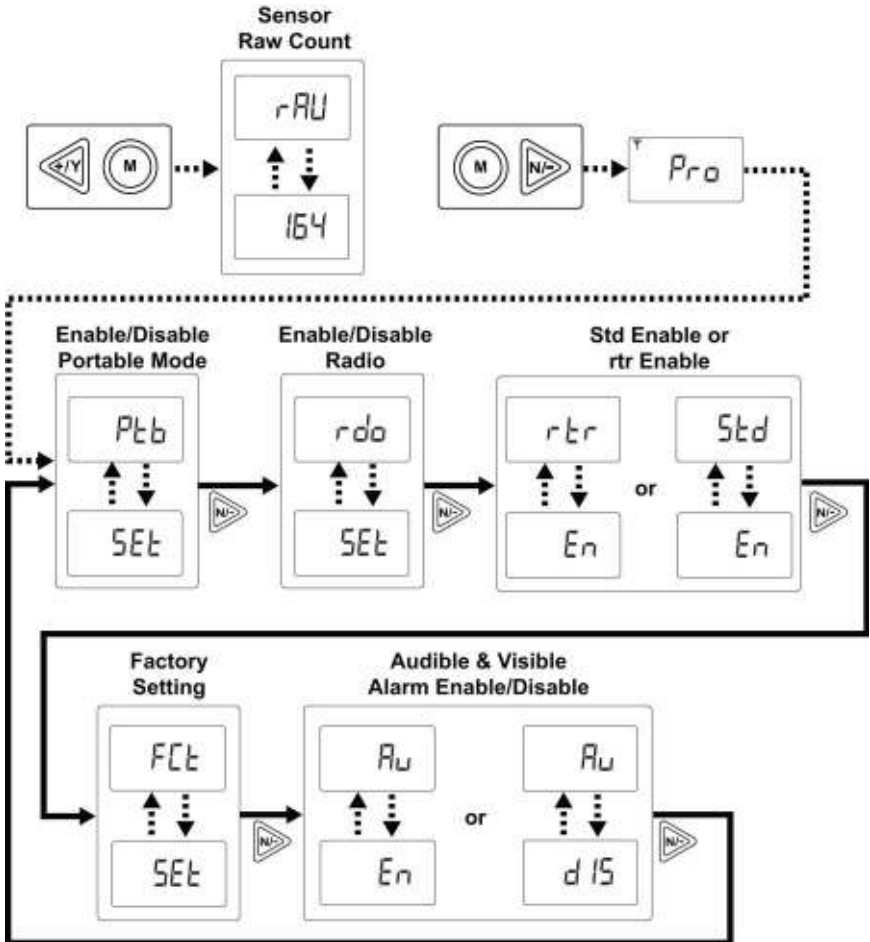

## MeshGuard User's Guide

---

### 6.4.1 Fixed Or Portable Operation Selection

The first menu is for setting the MeshGuard for fixed or portable operation. In Portable Mode, STEL, TWA, and Peak readings are included.

“SEt” and “Ptb” flash in alternation, to indicate that the MeshGuard can now be set as *fixed* or *portable*. The default value is “fixed.”

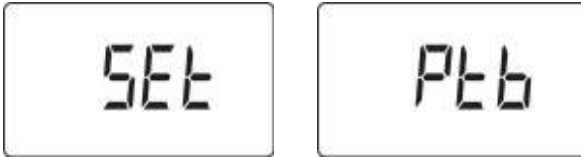

Press [Y/+] to enter and change the setting, [MODE] to exit and return to Detection Mode, or [N/-] to go to the next menu.

The LCD displays the current value (enabled or disabled). Change the value if necessary by pressing [Y/+] or [N/-]. Press [MODE] to enter your selection. Press [Y/+] to accept at this screen.

**Note:** “dIS” means fixed (Portable Mode disabled) and “En” means portable (Portable Mode enabled).



### 6.4.2 Radio Enable/Disable

The next menu is for setting turning the MeshGuard's radio on or off.

“SEt” and “rdo” flash in alternation, to indicate that the MeshGuard radio can be turned on (enabled) or off (disabled). The default value is “on.”

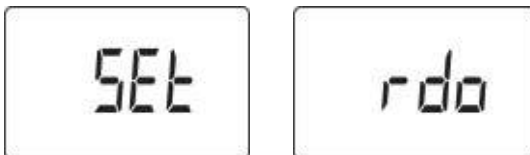

## MeshGuard User's Guide

---

Press [Y/+] to enter and change the setting, [MODE] to exit and return to Detection Mode, or [N/-] to go to the next menu.

The LCD displays the current value (enabled or disabled). Change the value if necessary by pressing [Y/+] or [N/-]. Press [MODE] to enter your selection. Press [Y/+] to accept at this screen.

**Note:** “dIS” means disabled (radio off) and “En” means on (radio on).



### 6.4.3 Std Enable or Rtr Enable

Press [Y/+] to toggle the setting from Std to Rtr, and vice versa.

### 6.4.4 Factory Setting

Press [Y/+] to return the MeshGuard to its original factory settings.

### 6.4.5 Audible & Visible Alarm Enable/Disable

Press [Y/+] to toggle between the MeshGuard's audible and visible alarms turned on and off.

## 7 Sensor And Battery Replacement



### 7.1 Battery replacement

1. Use the 3-pin end of the tool to unscrew and open the battery cover by turning it counterclockwise.
2. Remove the battery.
3. Insert the new battery with its positive (“+”) pole towards inside of the unit.
4. Replace the battery cover by turning it clockwise with the 3-pin end of the tool.

**Note:** Only change internal battery in a safe location and use the battery RAE Systems provided (P/N: 500-0111-000), model ER34615 or XL-205F.

# MeshGuard User's Guide

---

After changing the battery, wait at least 60 seconds before turning the MeshGuard on.

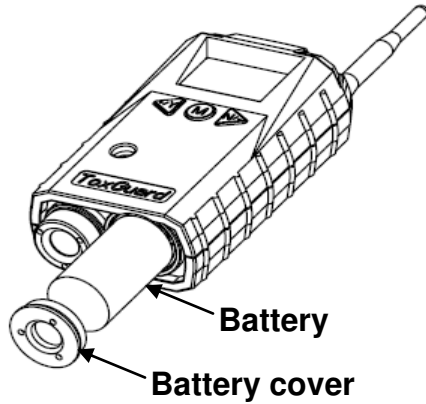

## 7.2 Proper Battery Disposal

This product may contain one or more sealed lead-acid, nickel-cadmium (NiCd), nickel-metal hydride (NiMH), lithium (Li), or lithium-ion batteries. Specific battery information is given in this user guide. Batteries must be recycled or disposed of properly.



This symbol (crossed-out wheeled bin) indicates separate collection of waste electrical and electronic equipment in the EU countries. Please do not throw the equipment into the domestic refuse. Please use the return and collection systems available in your country for the disposal of this product.

# MeshGuard User's Guide

## 7.3 Sensor Filter Replacement

1. Use the 3-pin end of the tool to unscrew and open the filter holder by turning it counterclockwise.

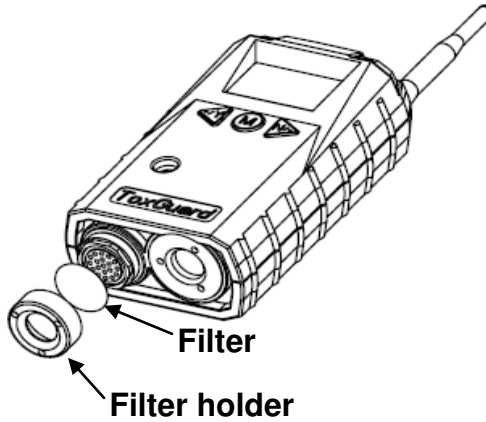

2. Remove and discard the filter.
3. Place a new filter inside the monitor.
4. Replace the filter holder by turning it clockwise with the 3-pin end of the tool.



## 7.4 Sensor Replacement

1. Use the 3-pin end of the tool to unscrew and open the filter holder at the bottom of the monitor.

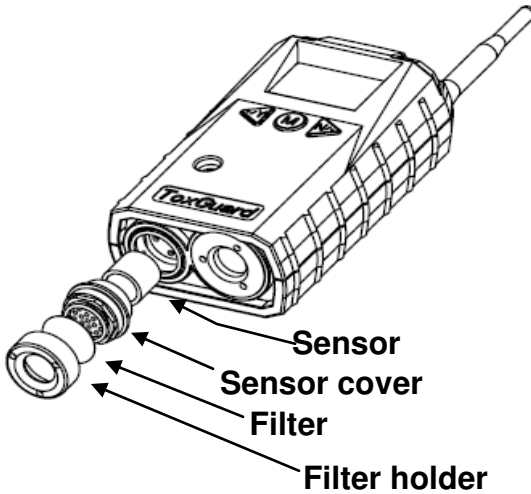

2. Use the hexagonal end of the tool to open the remove the sensor cover, turning counterclockwise.
3. Pull the old sensor out.
4. Gently push a new sensor into the compartment.

**Important!** Ensure that the RAE Systems part number matches the sensor that was removed.

**WARNING!** Use only the same sensor model as the one installed when the monitor was purchased.

5. Replace the sensor compartment cover using by turning it clockwise, using the hexagonal end of the tool.
6. Replace the filter holder by turning it clockwise, using the 3-pin end of the tool.

**Note:** Always recalibrate the MeshGuard after service to ensure functionality.

# MeshGuard User's Guide



## 8 Troubleshooting

Failure Symptom	Cause	Solution
Cannot turn on	<p>Battery charge too low</p> <p>Battery has been changed</p> <p>New battery needs to be discharged before use</p>	<p>Replace battery</p> <p>Wait at least 60 seconds to turn on MeshGuard</p> <p>Check RAE Systems web site for information on batteries</p>
Abnormally high reading	<p>Incorrect gas calibration</p> <p>Sensor low sensitivity to calibration gas</p>	<p>Recalibrate</p> <p>Replace the sensor</p>
“-0” Alarm	Sensor zero drift	Perform zero calibration
Controller cannot receive the MeshGuard's signal	<p>Too much distance between the MeshGuard and the controller.</p> <p>There is an obstruction between the MeshGuard and the controller.</p> <p>Controller does not receive completed data packet</p> <p>Battery is low</p> <p>MeshGuard and controller have different Pan ID numbers</p>	<p>The distance should be 300 m, line of sight. Deploy RTR MeshGuard or MeshGuard Router(s).</p> <p>Relocate the MeshGuard or deploy RTR MeshGuard or MeshGuard Router(s).</p> <p>Press [Y/+] on the detector to force it to send data packets</p> <p>Replace battery</p> <p>Set both units to have the same Pan ID number</p>



## MeshGuard User's Guide

No Antenna Icon	There is no reader or controller nearby. The controller or reader's network has changed.	Move the MeshGuard closer to a working controller or reader. Perform the network searching function in diagnostic mode.
	The MeshGuard is out of its RF range.	Move the MeshGuard close to a working controller or reader and Press [Y/+]
	Battery is low	Replace battery
Others		Turn MeshGuard off and on again.  Consult RAE Systems Customer Service.

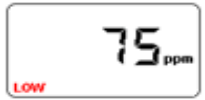
## 9 Alarm Signal Summary

Alarm Mode	When	LCD	Buzzer & LED
Over Range	Gas readings exceed the maximum value of the sensor		3 beeps per second
High Alarm	> high alarm setting		3 beeps per second
Low Alarm	> low alarm setting		2 beeps per second

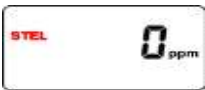
## MeshGuard User's Guide

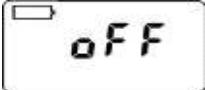
TWA	> TWA setting		1 beep per second
STEL	> STEL Setting		1 beep per second
Zero Drift	< 0 ppm		1 beep per second
Battery Low	< 3.2V		1 beep per minute
Battery Exhausted	< 3.1V		1 beep per second

## 10 Appendix A: Installation

Two methods for mounting MeshGuard make it easy to install. The first method uses a magnet that screw onto the rear of the MeshGuard, making ideal for moving from one location to another. The second method uses a specially designed stainless-steel enclosure that is permanently mounted. It protects the MeshGuard from damage in industrial settings.

### 10.1 Magnet-Mount Installation

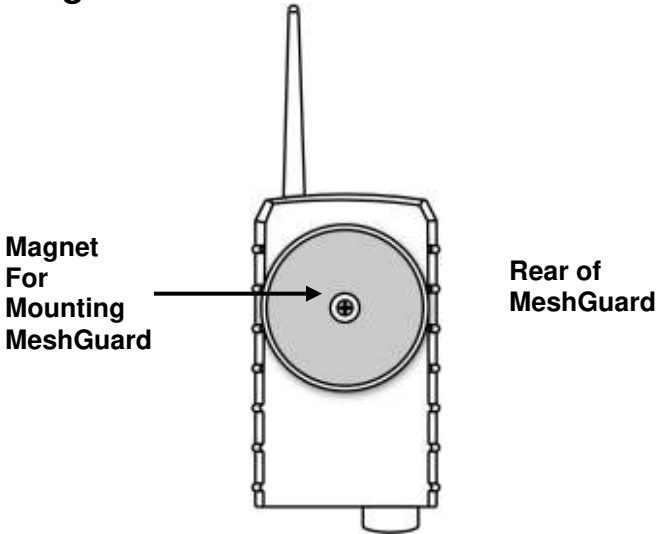

This magnet is powerful enough to support the MeshGuard when it is placed against a flat steel or iron surface.

**Important!** Keep the magnet away from computer hard drives. The strong magnet can corrupt or erase data on these.

# MeshGuard User's Guide

## 10.2 Fixed Installation

Four reinforced holes in the rear of the enclosure allow for a screw to pass through to the mounting brackets.

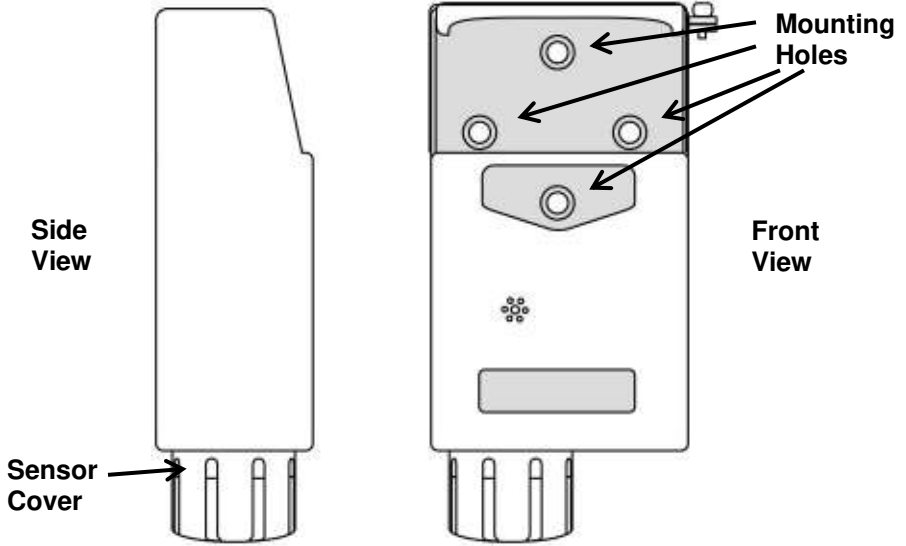

The enclosure can be mounted to a vertical or horizontal pole.

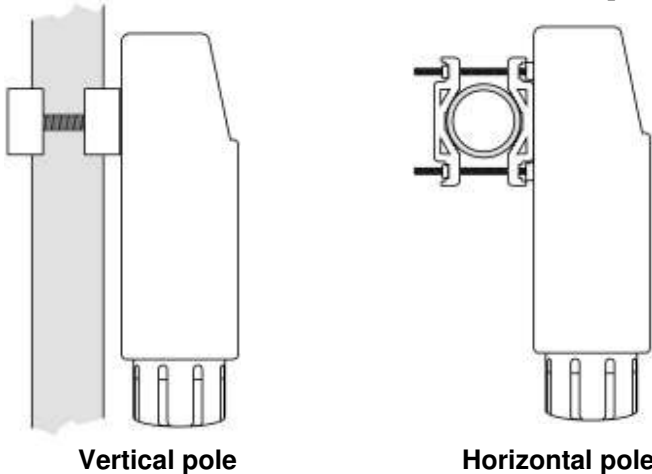

## MeshGuard User's Guide

---

Slip the screws through the two holes that are side by side in order to mount the enclosure to a vertical pole. Otherwise slip the screws through the two vertically aligned holes to attach the enclosure to a horizontal pole.

Loosely assemble the clamp parts around the pole. Note that the screws have nuts that fit into the clamp parts. The clamp parts are designed to hole the nut so that you do not need to use a wrench. Hand-tighten the parts until snug.

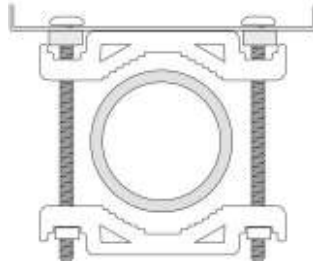

Tighten the hex screws from the front of the enclosure:



Once the clamp parts and the enclosure are securely held against the pole, stop tightening.

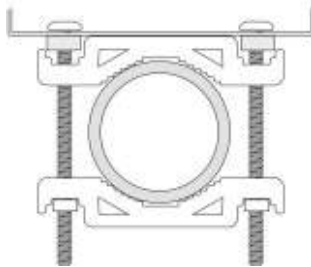

**Note:** The pole must be between 25mm (1") and 63mm (2.5") in diameter.

## MeshGuard User's Guide

Next, place the MeshGuard into the enclosure:

1. Lift up the hinged cover of the enclosure.
2. Slide the MeshGuard into the enclosure from the top.
3. Close the cover of the enclosure.
4. Insert the hex screw into the cover's locking portion, and tighten it.
5. The MeshGuard is now ready to use.

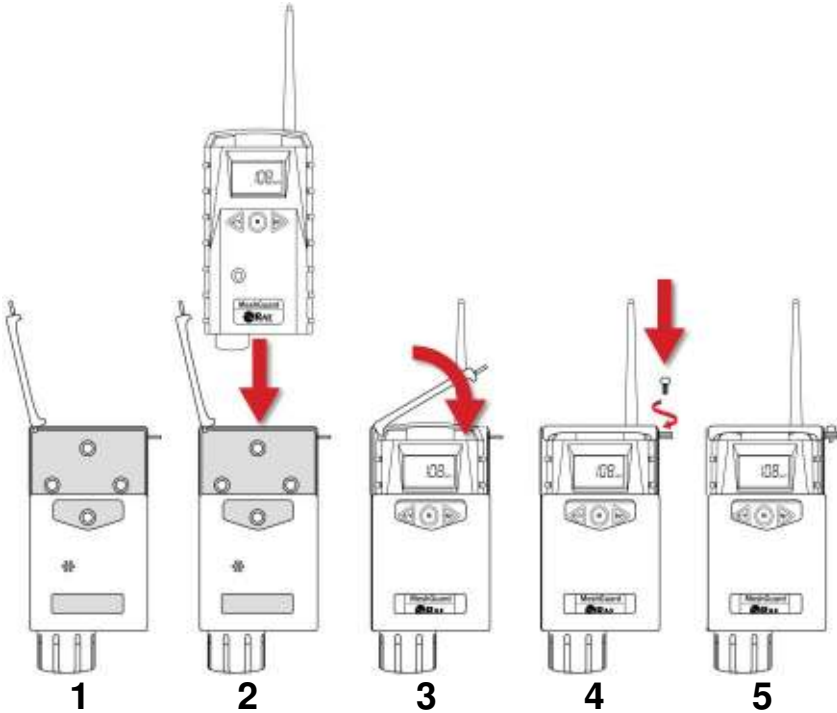

**Note:** The sensor cover on the bottom of the enclosure can be removed so that the filter and sensor can be inspected without removing the MeshGuard from the enclosure. Simply pull off the cover and follow the maintenance procedures in this guide.



## 10.3 Magnetic Mount Alternative Installation

The magnet-mount disc can be attached to the steel enclosure instead of the clamps. This approach provides the protection of the enclosure with the ease of installation afforded by the magnetic mounting.

1. Insert screw through magnetic disc.
2. Place the magnetic disc over the bottom hole on the rear of the enclosure.
3. Tighten the screw until the disc is snug.

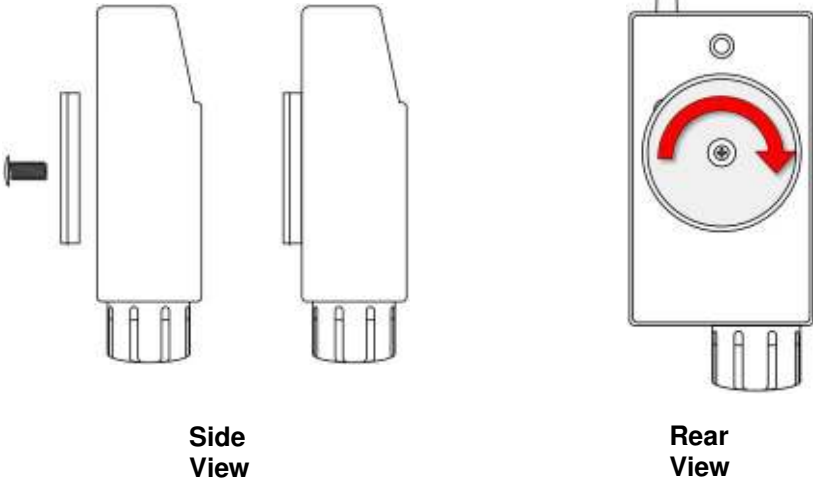

# MeshGuard User's Guide

---

## 11 MeshGuard Sensor Specifications

Sensor	Normal Range	Resolution	Response Time	Temperature Range
<b>H2S</b>	0 to 100 ppm	0.1 ppm	T <sub>90</sub> < 30 sec T <sub>10</sub> < 30 sec	-40° C to +50° C
<b>LEL*</b>	0 to 100% LEL	1% LEL	T <sub>90</sub> < 15 sec T <sub>10</sub> < 15 sec	-40° C to +50° C
<b>CO</b>	0 to 2000 ppm	1 ppm (0 to 500 ppm) 10 ppm (500 to 2000 ppm)	T <sub>90</sub> < 30 sec T <sub>10</sub> < 30 sec	-40° C to +50° C
<b>O2</b>	0 to 25%	0.10%	T <sub>90</sub> < 15 sec T <sub>10</sub> < 15 sec	-20° C to +50° C
<b>NH3</b>	0 to 100 ppm	1 ppm	T <sub>90</sub> < 90 sec T <sub>10</sub> < 200 sec	-20° C to +50° C
<b>CL2</b>	0 to 10 ppm	0.1 ppm	T <sub>90</sub> < 30 sec T <sub>10</sub> < 30 sec	-20° C to +50° C
<b>SO2</b>	0 to 20 ppm	0.1 ppm	T <sub>90</sub> < 60 sec T <sub>10</sub> < 60 sec	-20° C to +50° C

\* FTD-3000 only.

## MeshGuard User's Guide

---

<b>Sensor</b>	<b>Accuracy</b>	<b>Zero Drift (Over Full Temp Range)</b>	<b>Default Low Alarm</b>	<b>Default High Alarm</b>	<b>Default Span Value</b>
<b>H2S</b>	±10%	±1 ppm	10 ppm	20 ppm	25 ppm
<b>LEL *</b>	±10%	±5%	10%	20%	50%
<b>CO</b>	±20% (>500 ppm)	±10 ppm	35 ppm	100 ppm	500 ppm
<b>O2</b>	±0.4% vol or 2% of reading	±3% (0.75% Vol)	19.5%	23.5%	18%
<b>NH3</b>	±10%	±5 ppm	25 ppm	50 ppm	50 ppm
<b>CL2</b>	±10%	±0.3 ppm	0.5 ppm	5 ppm	5 ppm
<b>SO2</b>	±10%	±0.1 ppm	2 ppm	10 ppm	5 ppm

\* FTD-3000 only.

# MeshGuard User's Guide

---

**Ordering Replacement Parts:** If you need replacement parts, a list is available online: <http://www.raesystems.com>

## Year Of Manufacture

To identify the year of manufacture, refer to the serial number of the instrument.

The second to last digit in the serial number indicates the year of manufacture. For example, “M” indicates the manufacturing year is 2010.

First digit	Year
J	2008
K	2009
M	2010
N	2011
P	2012
Q	2013
R	2014
S	2015
T	2016
U	2017
V	2018
W	2019





**RAE Systems**  
**World Headquarters**  
3775 N. First St.  
San Jose, CA 95134-1708 USA  
Phone: 408.952.8200  
Toll-Free: 888.723.4800  
Fax: 408.952.8480

**E-mail (sales support):** [raesales@raesystems.com](mailto:raesales@raesystems.com)  
**E-mail (technical support):** [tech@raesystems.com](mailto:tech@raesystems.com)  
**Web Site:** [www.raesystems.com](http://www.raesystems.com)

### **RAE Systems Europe**

Kristinehøj 23A, Boulevard 69, DK-2770 Kastrup • Denmark  
Tel: +45.8652.5155 • Fax: +45.8652.5177

### **RAE Systems (Hong Kong) Ltd.**

Units 1516-18, 15/F, Delta House, 3 On Yiu Street  
Shatin, N.T. Hong Kong  
Web: [www.raesystems.cn](http://www.raesystems.cn) • Email: [asiasales@raesystems.com](mailto:asiasales@raesystems.com)  
Phone: +852.2669.0828

### **RAE Systems Middle East**

LOB 7, Ground Floor, Office 19, Jebel Ali Free Zone  
Dubai, United Arab Emirates  
Email: [mesales@raesystems.com](mailto:mesales@raesystems.com) • Phone: +971.4.887.5562