

**MICRO
PURGE[®]
BASICS**
▼QED

MODEL **MP50**

CONTROLLER/COMPRESSOR

PATENT PENDING

Instruction Manual

Part No. 95258 2-15-10



TTT Environmental
Instruments and Supplies

*The preferred source for instrument
Rentals, Sales, Service and Supplies!*

4201 B Street
Anchorage, AK 99503
(907) 770-9041

www.tttenviro.com

25420 74th Avenue S.
Kent, WA 98032
(253) 373-9041

info@tttenviro.com



QED

Environmental Systems

P.O. Box 3726 Ann Arbor, MI 48106-3726 USA
1-800-624-2026 Fax (734) 995-1170
info@qedenv.com www.qedenv.com



MP50 Basic Setup

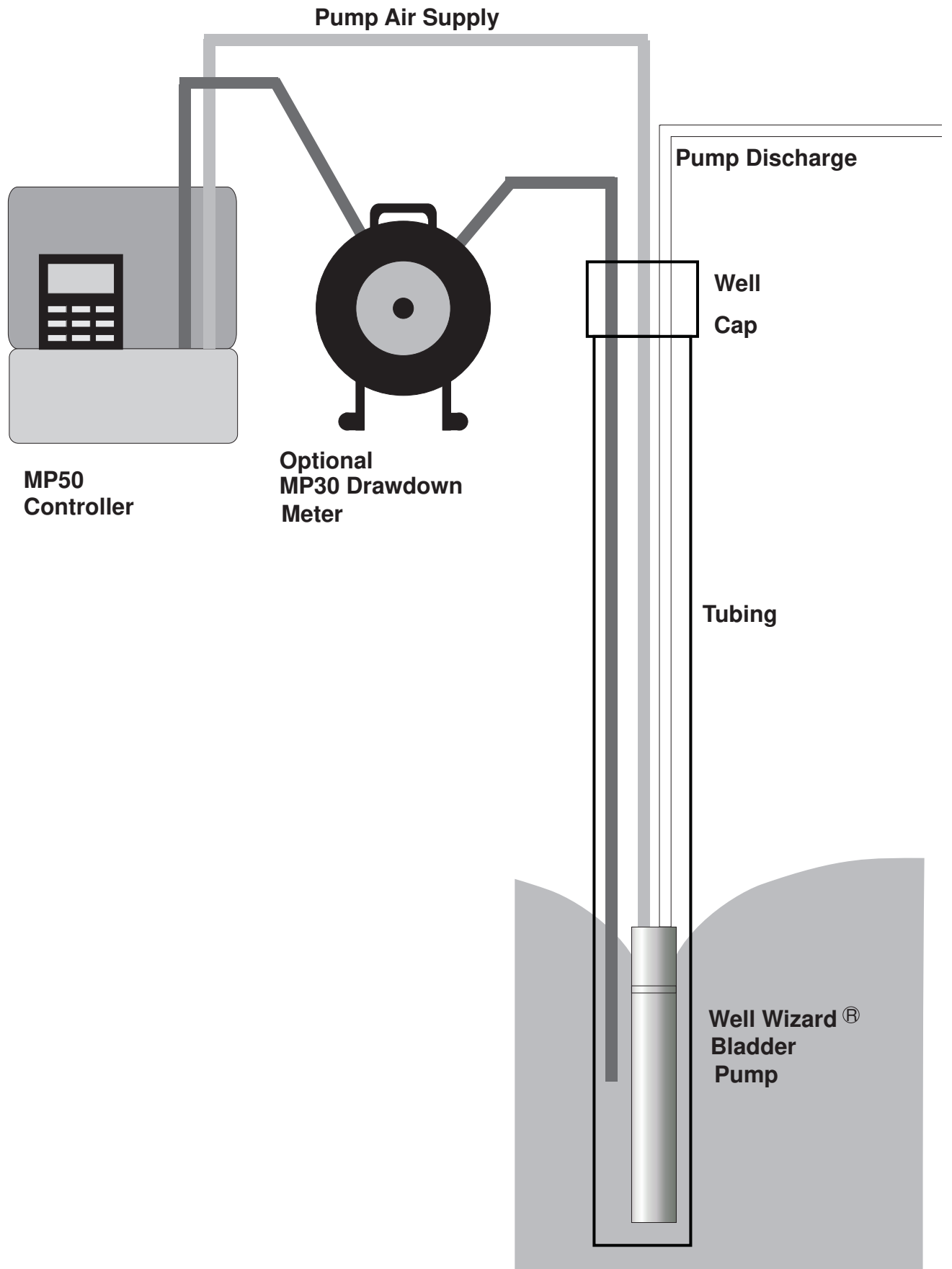

Contents

Topic	Page
Safety Warnings _____	1
Conventions and Diagrams _____	1
Introduction / Quick-Start _____	4
Bladder Pump Operation in Low-Submergence Applications _____	6
Turning the MP50 On _____	7
Opening Display _____	7
MicroPurge Mode _____	8
Using CPM _____	8
Sampling _____	10
Use with the MP30 Level Sensing Water Level Meter _____	11
ID Mode _____	14
User Time Set (MN) Mode _____	15
MP50 Battery _____	16
Troubleshooting _____	17
MP50 Specifications _____	18
QED Service Contacts _____	19
QED Warranty _____	20
Appendix 1 ID Data Table _____	21

Safety Warnings

Safety warnings

Compressed air - Use caution when working with compressed air or gas. Compressed gas cylinders are under extreme pressure and can cause unrestrained hoses to whip about dangerously. Do not over pressurize your controller. Failure to operate the controller within the pressure limits could result in failure. Read all operating instructions before operating the MP50 controller.

Warning - Do not disassemble the pneumatic pump while it is connected to a compressed gas source. Dangerous pressures could cause injury.

Diagrams and Conventions used in the Text

MP50 Panel Layout:

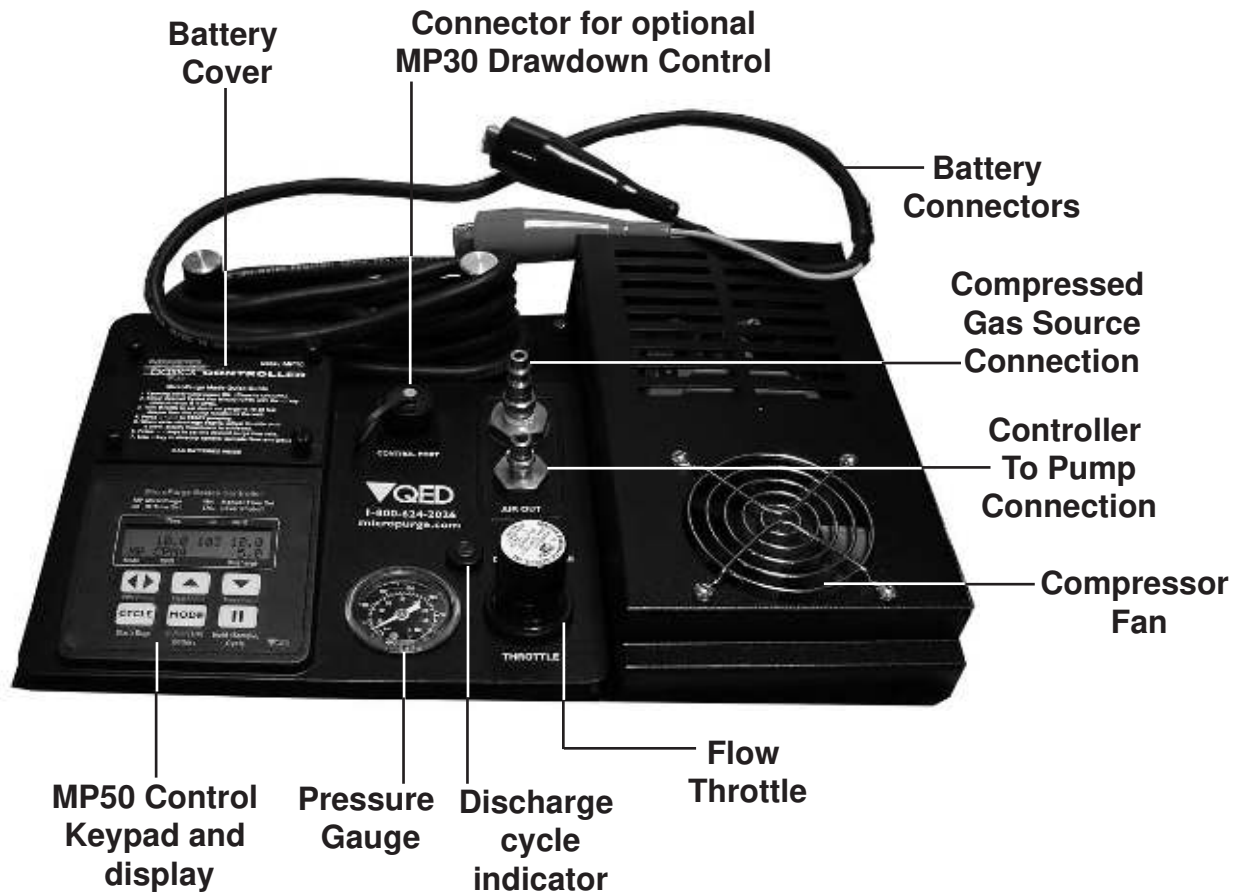

Diagrams And Conventions Used In The Text (Cont.)

MP50 Control Keys:

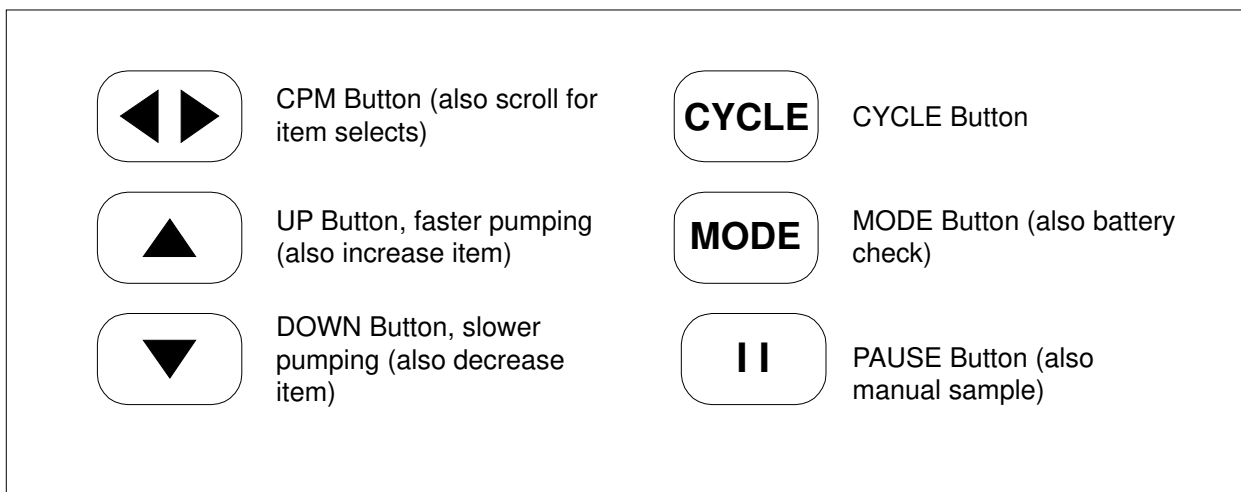
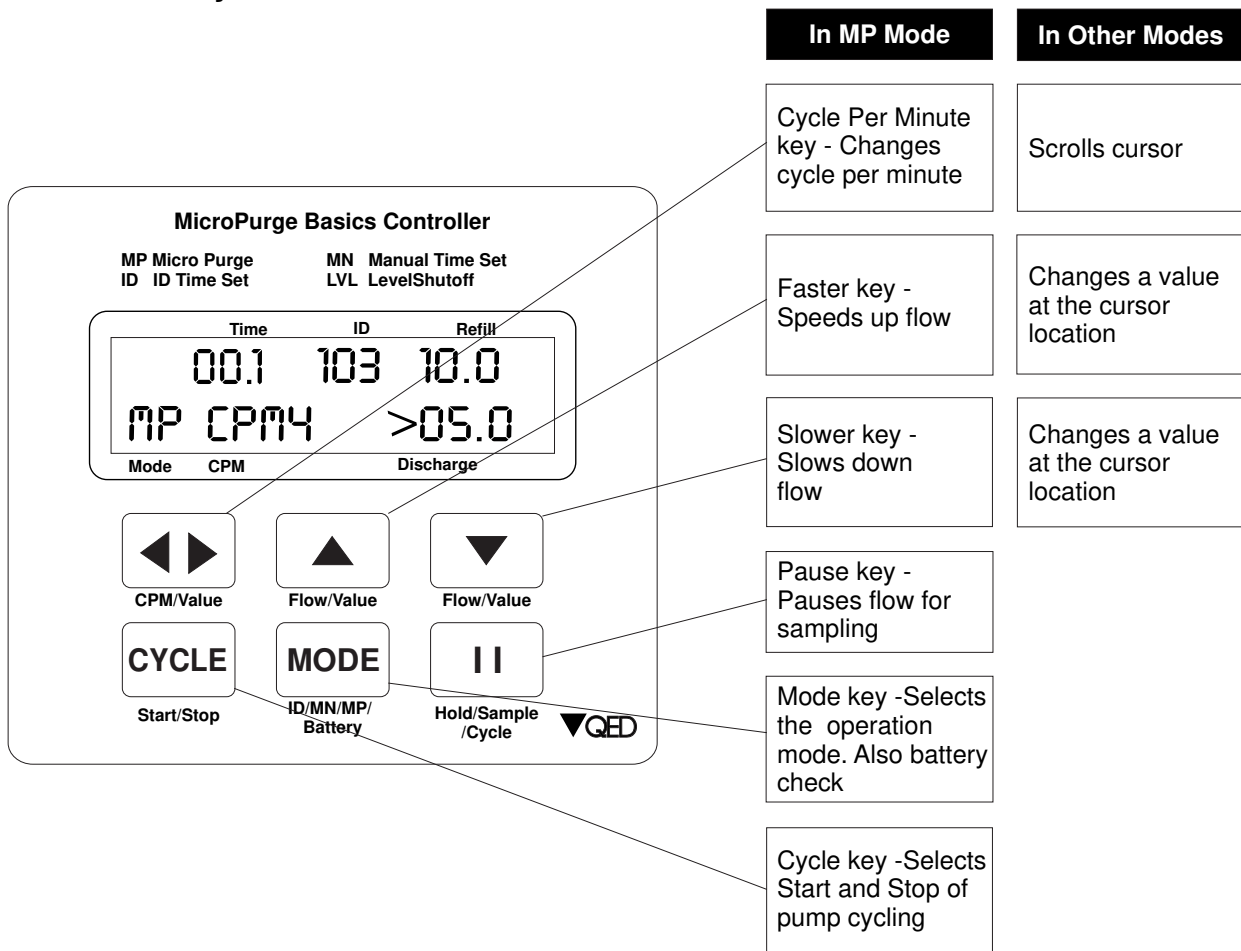

Diagrams And Conventions Used In The Text (Cont.)

MP50 Display:

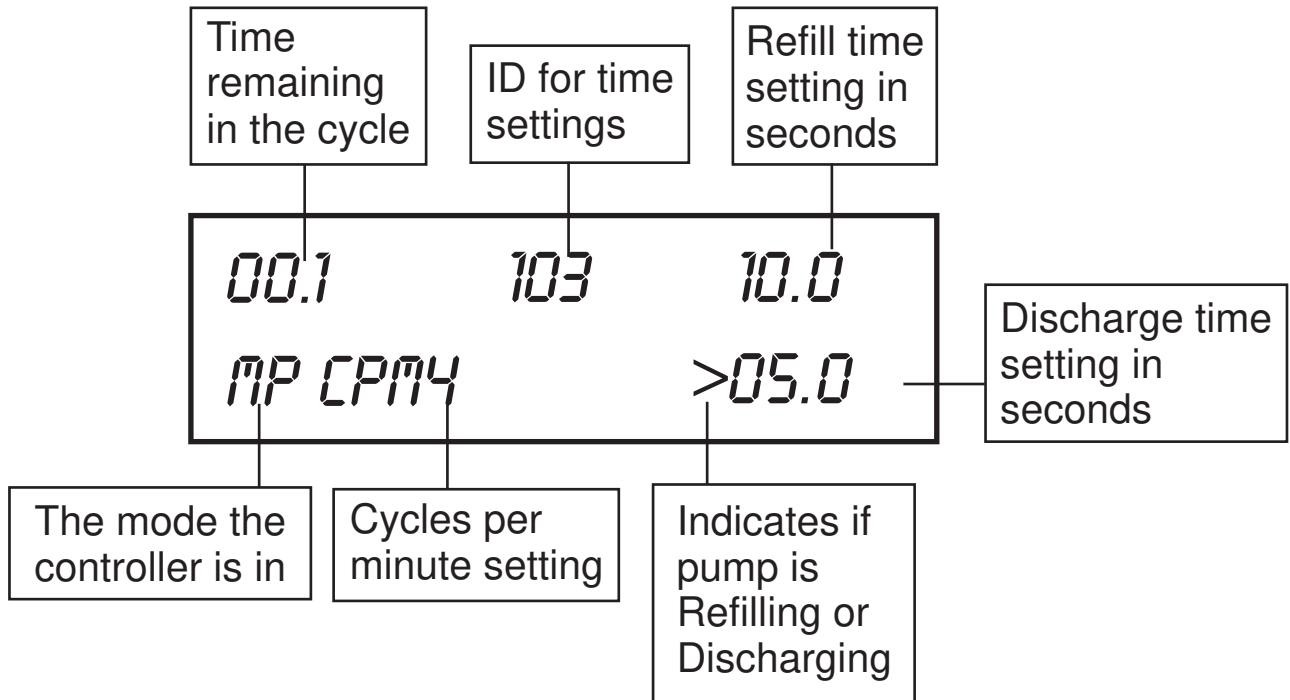

Abbreviations:

- CPM** Cycles Per Minute
- MP** MicroPurge Mode
- ID** ID Time Set Mode
- HELD** Held In A Cycle
- MN** Manual Time Set Mode
- BAT** Battery
- LVL** Level Pause
- >** Indicates Refill Or Discharge Cycle

Introduction / Quick Start

Introduction: The MP50 Micro Purge Basics Controller/Compressor is used to operate QED *Well Wizard™* bladder sampling pumps to purge and sample ground water. The MP50 has specific design features to make *MicroPurge™* sampling easier. These features include:

- **MicroPurge Mode Operation** Simple Increase / Decrease keys allow you to easily set the flow rate you need for each well.
- **ID Time Set Mode Operation** Quickly recalls pre-determined settings for each well by specifying a 3-digit ID.
- **Level Delay Interface** The controller plugs into the optional MP30 MicroPurge Drawdown / Water Level Meter to provide direct feedback of well drawdown and to pause pump operation until the level recovers.

The optional MP30 MicroPurge Drawdown / Water Level Meter plugs into the MP50 to provide water level feedback. The MP30 uses a standard conductivity probe to detect the ground water surface and a marked tape allowing the user to measure the depth. When the meter is set in MicroPurge mode, the probe is lowered a specific distance below the static water level and fixed in this position. During well sampling if the water level drops below the user-set probe position, the MP50 is paused which prevents further drawdown by the pump. Once the level recovers the MP50 begins pump operation again, starting in the pump refill cycle. Use of the MP50 with the MP30 is detailed later in this manual.

Insert Batteries: Remove the battery cover on the top of the MP50. Insert 3, AA alkaline batteries into the battery holder and carefully replace the holder in the carrier. Replace the battery cover and tighten the 4 screws. Batteries should last for about 6-8 weeks of typical full-time field use. If the MP50 will be stored longer than about 3 months, the alkaline batteries should be removed to prevent leakage.

Quick Start: Attach Red Positive (+) cable clamp to the Positive (+) terminal of battery. Attach Black Negative (-) cable clamp to the Negative (-) terminal of battery. Connect the light blue coiled pump hose to the fitting labeled “AIR OUT” on the MP50. Turn the controller throttle until the gauge reads the approximate depth of the sample pump (See Page 6) Follow instructions on the battery panel:

Opening the MP50 case turns power ON.



Note: It may take up to 20 seconds for the unit to power up.

Select desired Cycles Per Minute (CPM) with  (default value is 4 CPM, lower CPM for deeper wells, higher CPM possible with shallow wells-See Page 6).

Turn throttle to set depth on gauge to 10-20 feet deeper than the pump location in the well.

Press  to START pumping.

When water discharge begins, adjust throttle until a slow, steady flow-stream is achieved.

Press   keys to set the desired purge flow rate.

To collect samples, continue purge flow, or use  key to directly control sample flow and pause.

Note: An option to use an external air source is built into the MP50. To use external air source (rather than the built-in air compressor) simply connect the air source to the “Air In” port.

Note: A moisture vent is provided and located on the side of the MP50 case. Excessive accumulation of moisture can impede proper operation of the MP50. During cold and/or damp weather conditions, it is recommended that the moisture vent be pushed at frequent intervals during operation of the MP50.

Bladder Pump Operation In Low-Submergence

Bladder Pump Operation In Low-Submergence Applications

Pump submergence is defined as the height of the static water column above the top of the pump. In wells in which this water column height is 5 feet or less, the pump is considered to be in a low-submergence application.

QED sampling bladder pumps fill by hydrostatic pressure. As the inside of the pump's bladder fills with water, the bladder expands. This filling and expanding of the bladder is referred to as the "refill" half of the pump cycle. When air pressure is applied to the outside of the bladder, the bladder is squeezed, forcing the water up the discharge tubing. This is referred to as the "discharge" half of the pump cycle. In low-submergence applications, there is less water pressure available to expand the bladder during the refill.

This can result in a smaller volume of water being pumped with each pump cycle because the bladder may not fully expand.

As a result of the lower volume per cycle, more time will be required to bring the water to the surface. An easy way to verify that the pump is working, prior to the water reaching the surface, is to submerge the pump's discharge tubing in a beaker of water. Each time the pump goes into discharge, air in the discharge tubing, which is displaced as the water level in the tubing rises, can be seen as air bubbles coming from the end of the tubing. To optimize the pumping rate, the refill time should be set long enough to achieve the maximum volume of air bubbles on each pump cycle, and the discharge time should be set long enough to ensure that the air has stopped bubbling out of the tube before the pump controller switches back into refill.

In low submergence wells, ***it is critical that the air pressure driving the pump not be more than 10-15psi higher than the minimum requirement of 0.42psi per foot of pump depth.*** Higher pressures than this can cause the bladder to be squeezed too tightly during discharge, a condition which can prevent the bladder from expanding during refill. To avoid this condition in deeper wells, it is suggested that the air pressure applied to the pump be gradually increased as the water level in the pump's discharge tubing rises. It is recommended that the air pressure be set at 15 psi initially, and slowly increased in increments of 10 psi as needed until the water reaches the surface. Submerging the end of the discharge tubing under water as described above will verify whether the air pressure is set high enough.

Operation

Turning the MP50 Display On - The MP50 is powered on automatically by opening the lid. The MP50 displays an opening screen for 5 seconds, after which it displays the default MicroPurge screen. At this point the MP50 is in MicroPurge mode (MP) but not cycling the pump. This initial state allows the user to adjust time and throttle settings before the pump starts to operate. Pressing the Cycle key begins pump cycling. Times and modes may be adjusted while the pump is cycling or before. Pressing the Cycle key a second time will stop pump cycling.

Note: *all user-entered time settings are lost when the MP50 is turned off. Also, the MP50 automatically powers down when the lid is closed, so make sure the MP50 is stored with its lid closed.*

Opening Display - The opening display is shown for 5 seconds and displays the controller name, the version number and the battery voltage, as shown in Figure 1. Figure 1 shows that the battery is GOOD, that the battery voltage is 4.20 volts and that the software version in the controller is 1.0. Battery voltage must be greater than 3.6 volts for the unit to operate. If the unit fails to cycle replace the 3-AA batteries with fresh cells. The opening screen is displayed for 5 seconds, if you wish to by pass the opening screen, hitting any key, such as the CPM key will bring you to the default MP display.

Figure 1 Opening Screen

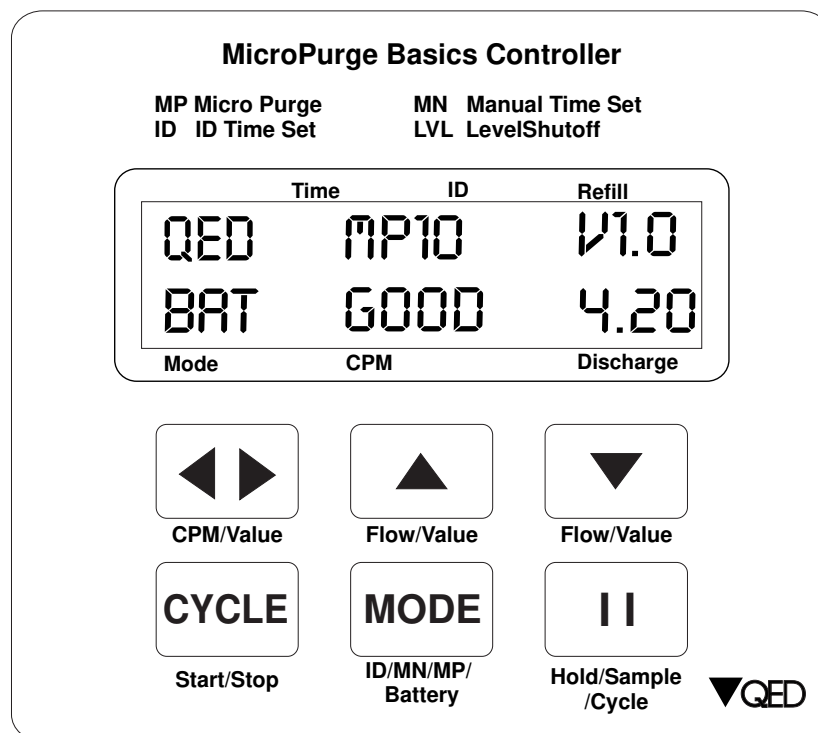

MicroPurge Mode Most MP50 users will leave the controller in the default MicroPurge (MP) mode. See Figure 2 for an example of the MP50 in MP mode. MP mode lets you to use the UP and DOWN keys to directly increase and decrease pump flow rates. The MP50 has a broad range of other CPM settings to ensure the availability of a time setting that will match your specific conditions. MP mode also displays an ID, with a value of 1 to 165 that matches the flow settings (CPM and refill and discharge times you have set). This ID should be noted alongside the well identification (QED provides custom weatherproof ID badges for purchasers of our MP series of well caps) for quick setting of the optimal controller settings on the next visit by using the MP50 in ID mode.

Figure 2 MP50 MicroPurge Mode

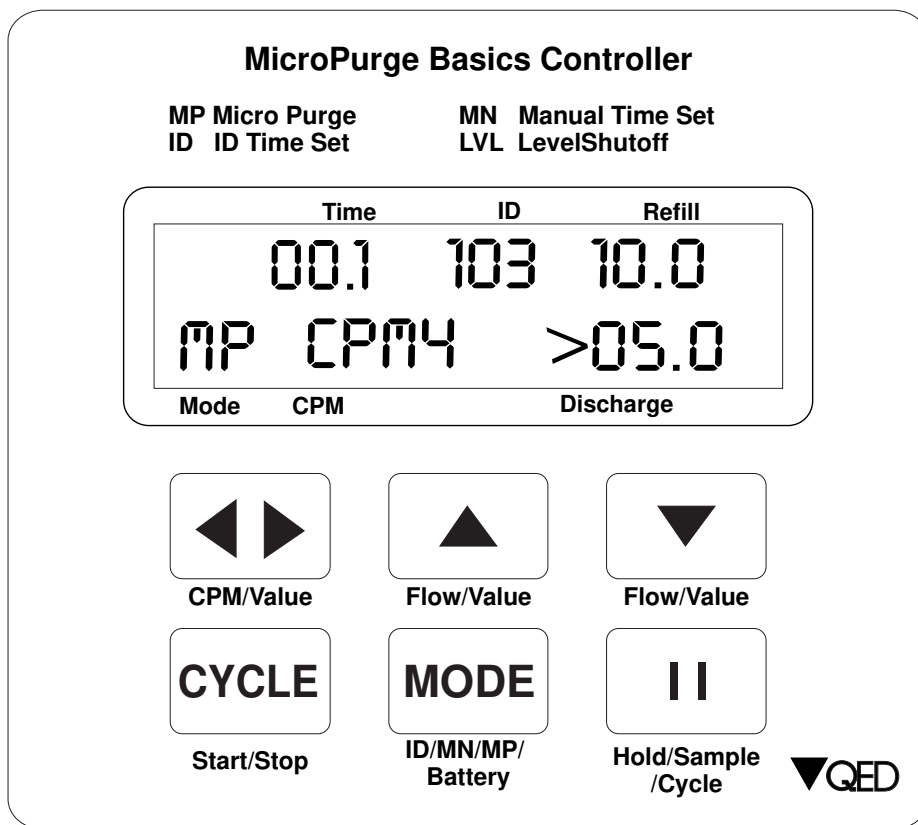

Using CPM The MP50 introduces a revolutionary, simpler way to control bladder pump flow rate and achieve the low-flow method used by experts. Up/down arrow keys are used to adjust pump flow even at very low rates, with excellent control and repeatability.

With previous bladder pump controllers, a leading low-flow technique called for selecting the number of pump cycles per minute, then adjusting the bladder pump discharge and refill times to achieve the desired volume per cycle. These adjustments were interrelated, complex, and varied by operator. The new MicroPurge Mode (MP) of the MP50 builds in a "cycles per minute", or CPM, method of flow control.

Operation

With this method, the number of complete pump cycles per minute is fixed, within a range of 1 to 6; 4 CPM is the default value which appears at startup. Each time the up/down arrow keys are pressed, the pump refill and discharge times are both automatically adjusted to maintain the selected CPM value. Each adjustment increases or decreases the volume pumped per cycle, and the per-minute flow rate is the volume per cycle X the CPM value.

For example, with a 4 CPM setting, 60 ml volume per cycle equates to $4 \times 60 = 240$ ml/min flow rate. A single press of the Flow up arrow key could change the volume per cycle to 80 ml, for example, resulting in a new, increased flow rate of $4 \times 80 = 320$ ml/min. And the MP10 assigns a unique identification value to each setting, the ID value, which can be directly set during later sampling events.

"MP" displayed in the lower left corner of the display indicates MicroPurge mode. The default CPM setting of 4 cycles per minute is a good starting point for wells with depths from 25-100 ft. MicroPurge mode starts at a time setting of 10 seconds refill and 5 seconds discharge, close to optimal for many wells. This startup settings corresponds to a 4 cycles per minute setting (CPM4) and an ID setting of 103.

Using the CPM key will change the CPM setting on the controller. The range of CPM settings is CPM1 through CPM6. CPM changes like this each time you hit the CPM key: 4 5 6 1 2 3 4 5, etc. The UP and DOWN keys change the flow rate directly, by altering the refill and discharge times *within* a CPM setting.

Note: *changes in settings that are entered while the controller is cycling are reflected on the next cycle change (so a long refill time of 15 seconds will time out before a new refill time becomes valid).*

Here is an example of the use of the UP (faster) key:

Key Press	Refill (sec)	Discharge (sec)	ID
---	10.0	5.0	103
1	9.5	5.5	104
2	9.0	6.0	105
3	8.5	6.5	106

Operation

Each of the 165 possible ID settings corresponds to a unique ID that is associated with CPM, refill and discharge time values. For typical usage, only the UP/DOWN arrow keys are required to set flow, and the ID number is provided for easy, direct return to past settings. Appendix 1 lists all possible ID settings and the default refill and discharge time settings for each CPM. Appendix 1 also shows how the refill and discharge time will change within a CPM setting as you press the UP or DOWN keys.

Sample Collection The PAUSE key () is used to freeze the controller action to allow the user time to collect a sample or carry out other steps that might be difficult if the controller continued to automatically cycle and cause the pump to produce water. While the controller is cycling, pressing the PAUSE key causes the controller to immediately enter the Hold state. Drive air is vented from the pump (this is the pump refill cycle) and the pump fills and waits. Pressing the PAUSE key a second time causes the controller to immediately enter the Sample state. Drive air is directed to the pump causing the pump to discharge its volume of liquid. Bladder pumps typically hold 400-500 ml of liquid, so use of the Hold and Sample states allow the full volume of the pump to be discharged into a sample container. Pressing PAUSE once again returns the MP50 to its normal Automatic Cycling state. During Hold and Sample a HELD is displayed to remind you that the controller is in a paused state. Figure 3 shows an example of the MP50 in MP mode, but HELD in the Sample state.

Note: Pressing the Cycle key also freezes controller cycling. However, using the Cycle key rather than the Pause key causes the startup screen to be displayed upon restart. Use of the Pause key is recommended for typical operation.

Figure 3 MP50 Held State (MP mode)

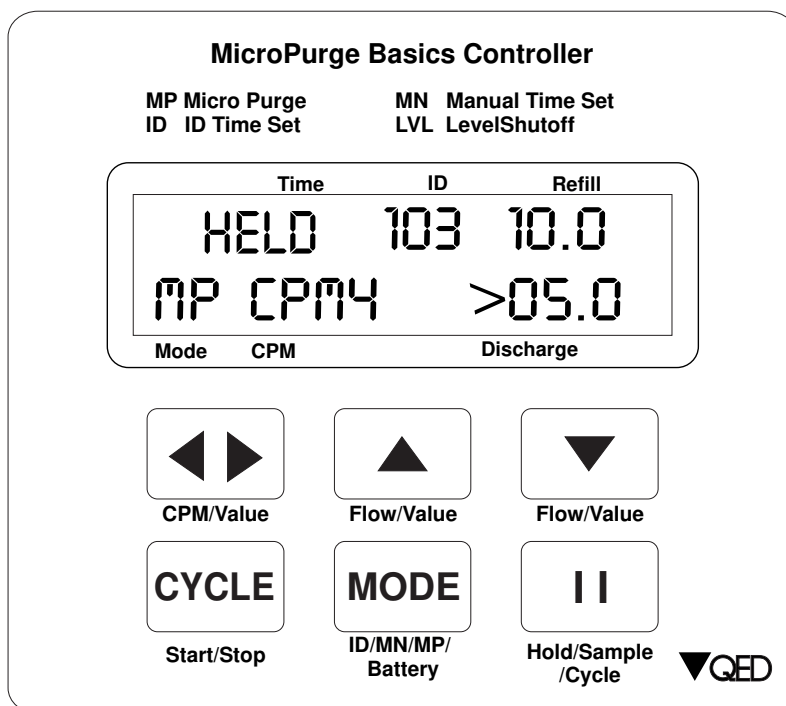

Warning: in the HELD SAMPLE state the pump, tubing and hoses are all under pressure. **DO NOT** attempt to disconnect or disassemble any part of the system when it is under pressure. The system is under pressure if the pressure gauge shows a value greater than 0 and the RED Discharge Cycle Indicator is showing.

Flow Throttle Use The flow throttle is used during sampling to regulate the pressure applied to the pump. Turning the throttle clockwise increases the pressure and counterclockwise decreases the pressure. The pressure gauge shows the approximate pressure applied to the pump and reads in units of Feet - H²O. This allows easy adjustment of the throttle giving pressures that will produce gentle, non-turbulent flow (normally 10-20 Feet - H²O deeper than pump depth). For traditional, high volume purging pressure may be increased with the throttle to maximize pump flow during well purging.

Use with the MP30 Automatic Drawdown Control The MP50 may optionally be used with the MP30 MicroPurge Drawdown / Water Level Meter. See Figure 4 for an example of the MP50 in MP mode with the controller in a level paused state enacted by an MP30 meter.

Figure 4 MP50 Level Paused State (MP mode)

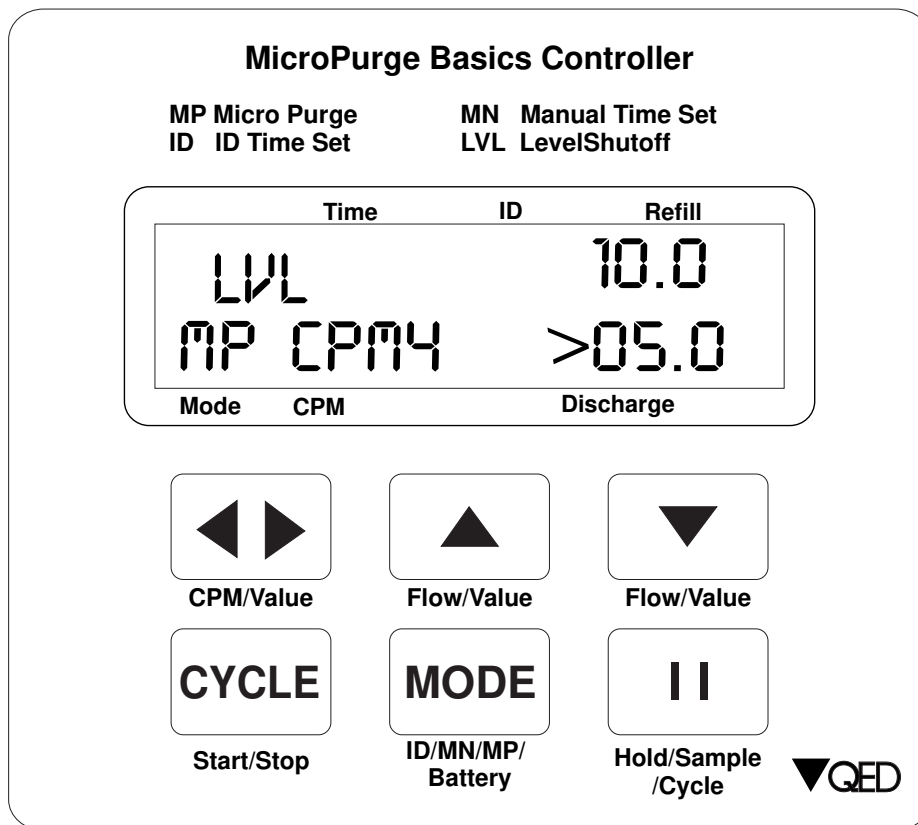

Figure 5 MP50 MP30 Use

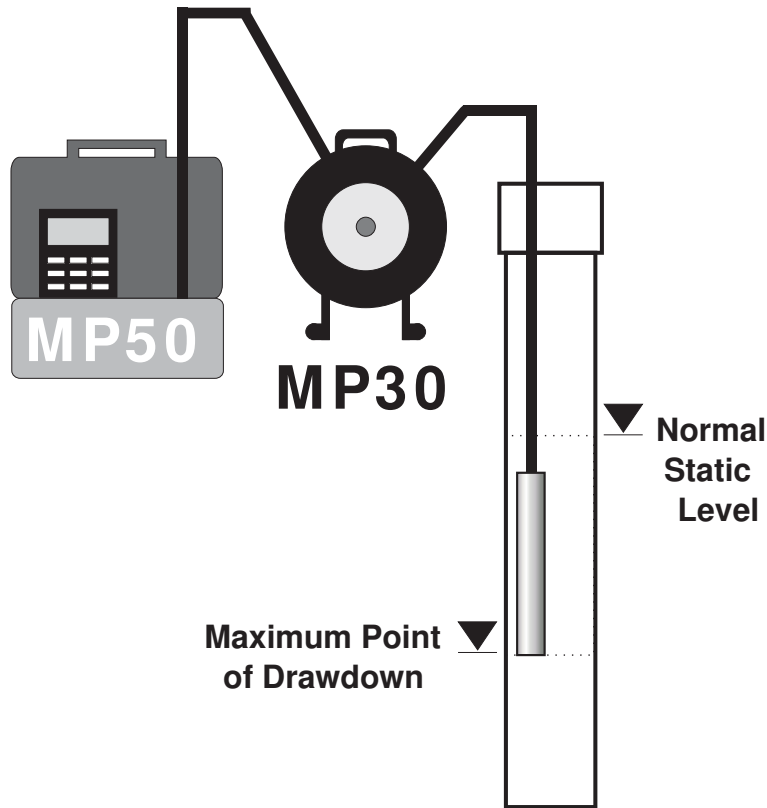
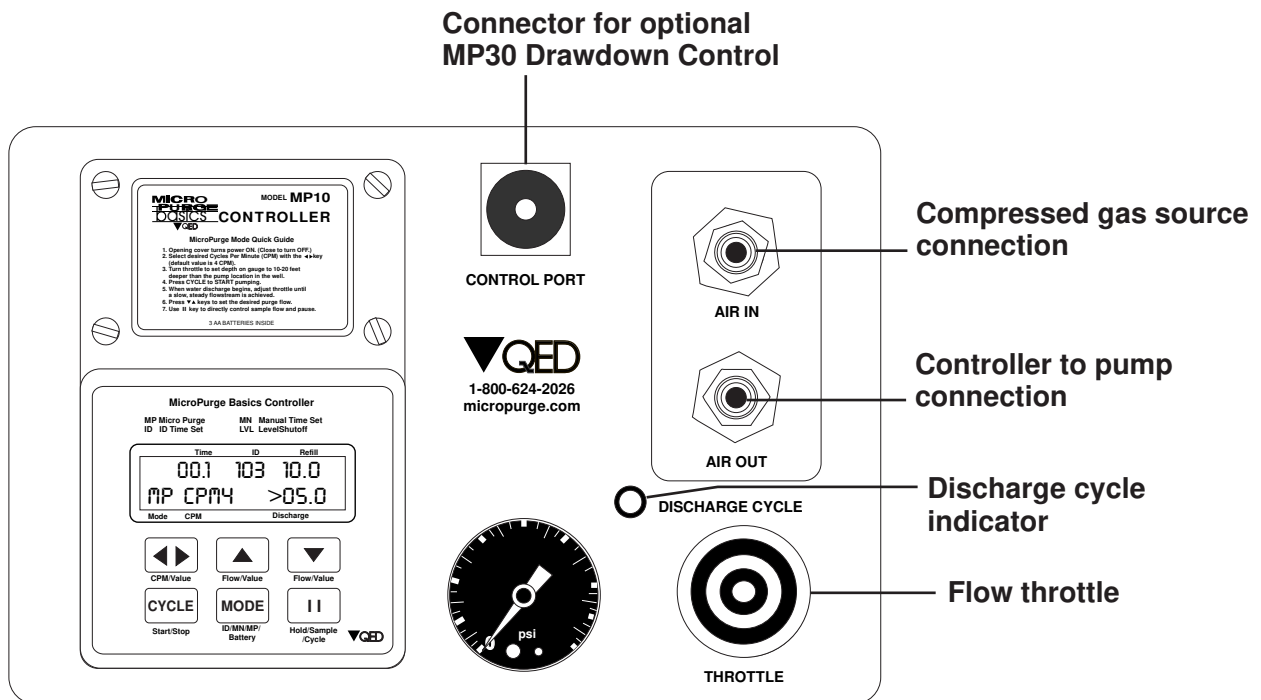

Figure 6 MP50 MP30 Use



The MP50 and MP30 are connected with a cable (see Figures 5 and 6). The MP30 is switched into mode and the water level probe is lowered to the desired maximum drawdown level. Limiting the maximum drawdown depth limits the differential head driving flow into the well and the velocity of the water flowing into the well from the surrounding formation important in Micro-Purge sampling. The MP50 and MP30 work together to automatically adjust the pump operation so as to maintain drawdown at the set level. When the water level drops below the probe, the MP30 sends a signal to the MP50 to pause pumping. Both the MP50 and the MP30 give visual signals (and the MP30 emits an audio signal) that pump operation has stopped because of too much drawdown. Once the level recovers, the MP30 signals the MP50 to resume pump operation. The MP50 resumes by starting in the refill leg of the pump cycle. "DRAWDOWN CONTROL"

The normal operating mode for using the MP30 with the MP50 is:

1. Use the MP30 in standard WLM mode to determine the static water level in the well
2. Decide what the maximum drawdown for that well is during sampling
3. Lower the probe to the maximum drawdown level
4. Switch the MP30 into Drawdown Control mode
5. Begin pumping with the MP50
6. Observe the interactions between the two devices, if the MP30 is frequently pausing the MP50, it may be appropriate to slow the flow down (using the DOWN key in MP mode) to better match pump flow to well recharge.

When switched into mode, the MP30 has a flashing red light and an optional (can be switched off by the user) audio alarm to indicate when the probe is in the dry state. A submerged probe in all modes is indicated by a solid green light. When the MP50 is paused by the MP30 the MP 50 display indicates this as shown in Figure 4 "DRAWDOWN CONTROL"

Operation

If the MP30 is signaling the MP50 too frequently, the operator can slow down the pump flow rate by using the DOWN key (effectively increasing the pump refill time period). MP30 probe position may also be varied to provide a buffer zone for your drawdown limit and gauge rate of pumping effect on water level in the well.

If the selected maximum drawdown level is being reached even with the lowest desirable pump flow rate more drawdown may be required to attain equilibration, or a passive sampling approach may be required. In passive sampling, used where well recovery is extremely slow, samples are taken after just a few pump strokes sufficient to purge the pump and tubing volumes.

Additional information on the MP30 is given in the MP30 O&M manual

ID Mode Figure 6 shows an example of the MP50 in ID time set mode. Once you've used the MP50 in MP mode and found proper settings for your wells, subsequent sampling events are speeded along by using the controller in ID mode. Once the controller is turned on, a single press of the MODE key places the controller in ID time set mode (the default initial mode is MP mode). This mode allows the user to enter a 3-digit ID, which then is translated into the correct flow settings (CPM and refill / discharge time settings) for that well.

Figure 7 MP50 ID Set Mode

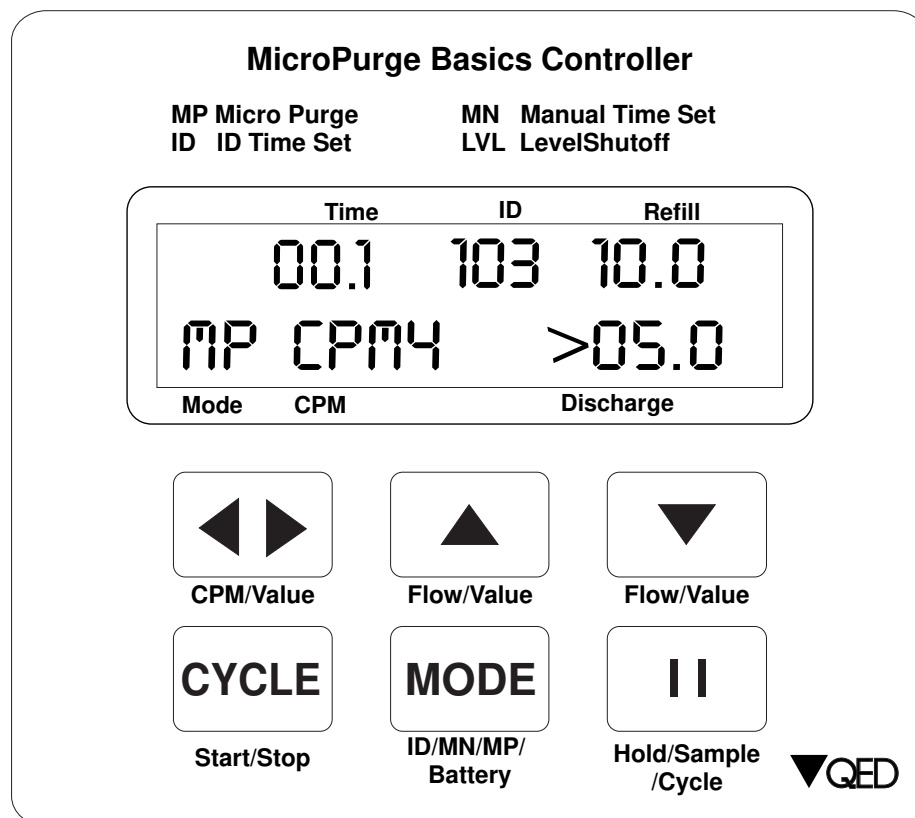

In this mode the CPM and UP, DOWN keys function differently. The CPM key becomes a key used to scroll between the one's and the ten's digits of the ID. The UP and DOWN keys are used to change the ID number (the MP50 has IDs that range from 1-165) up or down in value. Sampling in ID mode is the same as explained, above, for MP mode.

Appendix 1 lists all possible ID settings and the default refill and discharge time settings for each CPM. Appendix 1 also shows how the refill and discharge time will change within a CPM setting as you press the UP or DOWN keys. As you change IDs you will see the CPM change and the refill and discharge time setting change.

Note: changes in time settings that are entered while the controller is cycling are reflected on the next cycle change (so a long refill time of 15 seconds will time out before a new refill time becomes valid).

User Set Mode A final controller mode, User Set mode (MN on the display), is useful for manually setting refill and discharge times on the controller as in traditional controllers (like previous model QED pump controllers). An example of the MP50 in User Set mode is shown in Figure 8. User set mode is also used when the wells being sampled are at extreme depths or there are other conditions where one of the 165 possible preset times of ID and MP modes will not match your needs. MN mode is entered when the MODE key is pressed twice from the default MP mode. As shown in Figure 8, the display indicates MN mode in the lower left corner and CPM and ID are not displayed.

Figure 8 MP50 User Set Mode (MN mode)

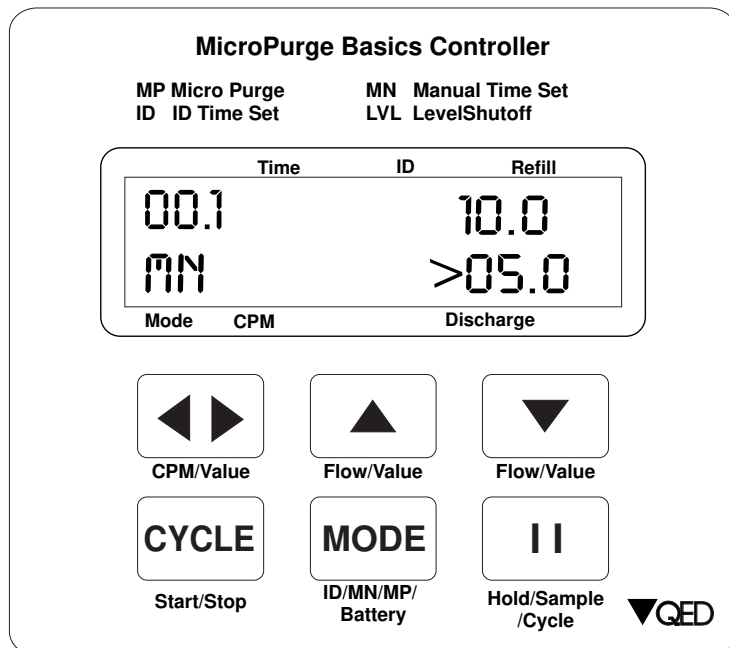

Operation

In User Set mode the CPM and UP, DOWN keys function differently than MP mode. The CPM key becomes a key used to select the digits of the refill and discharge time settings found at the rightmost positions on the display. The UP and DOWN keys are used to adjust the digit value up or down. By selecting and adjusting digits up and down a user can quickly set any time from 00.1 seconds to 99.9 seconds. Sampling in User Set mode is the same as explained, above, for MP mode.

The MP50 does not attempt to translate a user set time into a corresponding ID or CPM. Also, any settings you have entered in MP or ID modes are lost once you press the MODE key to enter MN mode.

Note: *changes in time settings that are entered while the controller is cycling are reflected on the next cycle change (so a long refill time of 15 seconds will time out before a new refill time becomes valid).*

MP50 Battery - The MP50 features sophisticated power-supply circuitry that optimizes battery life. A fresh set of AA batteries will provide more than 100 hours of controller operation at normal operating temperatures. As ambient temperatures drop below 15-20°F (-9°C to -6°C), the ability of the alkaline batteries to deliver energy is affected. Continuous operation may be difficult in extremely cold conditions. Once the batteries and MP50 warm, additional cycle capacity will be regained from a set of batteries.

Replace alkaline batteries by removing the 4 thumbscrews located on the battery cover and inserting 3 fresh **cells**. The MP50 battery holder includes space for **3 spare AA cells** so you should never be without power in the field. Properly dispose of the spent alkaline cells.

Note: *If you are storing the MP50 for more than 3 months, remove the AA batteries to prevent leakage. The MP50 power supply is automatically shut off by closing the lid. Make sure the lid is closed during storage.*

Troubleshooting

Troubleshooting

Use the following troubleshooting table to assist in troubleshooting the MP50:

Symptom	Possible Cause	Action / Fix
Display not showing	Low or dead batteries Batteries installed wrong	Check battery voltage on opening display (>3.6 volts required) Replace batteries Check battery connection
Controller not cycling	Low or dead batteries	See, above
	Lid not open	Open lid
	Temperature below 10° F	Warm controller
	MP50 not STARTED with CYCLE key MP50 in HELD mode	Operate CYCLE and/or PAUSE key to return MP50 to cycling state
Air not cycling through controller	MP50 in LEVEL hold	Make sure MP30 probe is submerged when in MP mode
	Throttle turned too low	Turn throttle clock-wise to produce pressure
Pump not pumping	Air source not delivering air	Verify air source
	Throttle turned too low	Turn throttle clock-wise to produce pressure
	Time settings not correct	Try different CPM settings (lower CPM for deeper wells) and/or different refill and discharge time settings
Battery life too short	Air source pressure too low	Verify air source pressure
	Controller left on while stored	Turn MP50 off before storing and remove batteries when storing more than 1 month
	Temperature below 10° F	Warm controller

Specifications

MP50 Specifications

Temperature Range:	Operating range of -20° F to +120° F
Humidity:	Circuitry sealed to provide operation to 100% humidity
Protection:	Circuitry protected against transient surges introduced from improper battery installation or switch connections
Dimensions:	16" x 13" x 6.5"
Weight:	21 lbs
Case Material:	Structural Resin
Keypad:	6 keys
Display:	LCD display, 32-character (2 lines, 16 characters, each)
Window:	Non-glare, double hardened optical acrylic
Controller Power:	3 "AA" Batteries
Controller Battery Life:	50,000 Cycles @ 70° F (21° C)
Drain:	Unit off: 2mA, Unit on: 4mA, Valve Cycle: 6mA
Reserve:	100 hours operating time (1sec/1sec cycles) with fresh AA alkaline cells At 65° F (approx.)
Emergency battery:	3 AA cells stored within battery compartment
Compressor Power:	12 VDC (Battery Cable)
*Max. Lift:	200 Feet (60 m)
Output:	0.21 SCFM@ 100 psi (0.357 m ³ /h@ 6.89 kPa)
Max. Pressure:	105 psi (7.24 kPa)
Operating Temperature:	-20° - 120° F (-29° - 49° C)
Connection to MP30 Drawdown Meter:	Heavy-Duty Cable (Supplied with MP30)

*Pump flow rates in deeper wells (>100 feet) will be reduced, especially for pumps with less than 10 feet liquid submergence.

For additional assistance contact QED Service at:

Phone:	1-800-624-2026 1-734-995-2547
Fax:	1-734-995-1170
E-mail:	service@qedenv.com
24-Hour Service Hot Line:	1-800-272-9559

QED Monitoring System WARRANTY

QED ENVIRONMENTAL SYSTEMS, ("Q.E.D.") warrants to the original purchaser of its products that, subject to the limitations and conditions provided below, the products, materials and/or workmanship shall reasonably conform to descriptions of the products and shall be free of defects in materials and workmanship. Any failure of the products to conform to this warranty will be remedied by Q.E.D. in the manner provided herein.

This warranty shall be limited to the duration and the conditions set forth below. All warranty durations are calculated from the original date of purchase.

- 1. *Dedicated-Use Systems Products***- 10 year warranty on dedicated bladder pumps equipped with Q.E.D. inlet screens, and purge pumps used in periodic, non continuous groundwater sampling (up to 52 sampling events per year.)All other components, equipment and accessories are warranted for one year.
- 2. *Portable-Use Systems***- Sample Pro Pumps, Controllers and water level meters are warranted for one year. Hose Reels, Caps and non-Sample Pro pumps are warranted for ninety (90) days. Tubing and Purge Mizers are covered by a ninety (90) day material and workmanship warranty. There will be no warranty for application on tubing and Purge Mizers when used as part of a Portable System.
- 3. *Separately sold parts and Spare Parts Kits***- Separately sold parts and spare parts kits are warranted for ninety (90) days. Repairs performed by Q.E.D. are warranted for ninety (90) days from date of repair or for the full term of the original warranty, whichever is longer.

Buyers' exclusive remedy for breach of said warranty shall be as follows: if, and only if, Q.E.D. is notified in writing within applicable warranty period of the existence of any such defect in the said products, and Q.E.D. upon examination of any such defects, shall find the same to be within the term of and covered by the warranty running from Q.E.D. to Buyer, Q.E.D. will, at its option, as soon as reasonably possible, replace or repair any such product, without charge to Buyer. If Q.E.D. for any reason, cannot repair a product covered hereby within four (4) weeks after receipt of the original Purchaser's/Buyer's notification of a warranty claim, then Q.E.D.'s sole responsibility shall be, at its option, either to replace the defective product with a comparable new unit at no charge to the Buyer, or to refund the full purchase price. In no event shall such allegedly defective products be returned to Q.E.D. without its consent, and Q.E.D.'s obligations of repair, replacement or refund are conditioned upon the Buyer's return of the defective product to Q.E.D.

IN NO EVENT SHALL Q.E.D. ENVIRONMENTAL SYSTEMS, INC. BE LIABLE FOR CONSEQUENTIAL OR INCIDENTAL DAMAGES FOR BREACH OF SAID WARRANTY

The foregoing warranty does not apply to major sub-assemblies and other equipment, accessories and parts manufactured by others, and such other parts, accessories, and equipment are subject only to the warranties, if any, supplied by the respective manufacturers. Q.E.D. makes no warranty concerning products or accessories not manufactured by Q.E.D. In the event of failure of any such product accessory Q.E.D. will give reasonable assistance to the Buyer in obtaining from the respective manufacturer whatever adjustment is reasonable in light of the manufacturer's own warranty.

Warranty

THE FOREGOING WARRANTY IS IN LIEU OF ALL OTHER WARRANTIES, EXPRESSED, IMPLIED OR STATUTORY (INCLUDING BUT NOT LIMITED TO THE WARRANTIES OF MERCHANTABILITY AND FITNESS FOR A PARTICULAR PURPOSE), WHICH OTHER WARRANTIES ARE EXPRESSLY EXCLUDED HEREBY, and of any other obligations or liabilities on the part of Q.E.D., neither assumes nor authorizes any person to assume for it any other obligation or liability in connection with said products, materials and/or workmanship.

It is understood and agreed that Q.E.D. shall in no event be liable for incidental or consequential damages resulting from its breach of any of the terms of this agreement, nor for special damages, nor for improper selection of any product described or referred to for a particular application.

This warranty will be void in the event of unauthorized disassembly of component assemblies. Defects in any equipment that result from abuse, operation in any manner outside the recommended procedures, use and applications other than for intended use, or exposure to chemical or physical environment beyond the designated limits of materials and construction will also void this warranty. Q.E.D. shall be released from all obligations under all warranties if any product covered hereby is repaired or modified by persons other than Q.E.D.'s service personnel unless such repair by others is made with the written consent of Q.E.D.

If any product covered hereby is actually defective within the terms of this warranty, Purchaser must contact Q.E.D. for determination of warranty coverage. If the return of a component is determined to be necessary, Q.E.D. will authorize the return of the component, at owner's expense. If the product proves not to be defective within the terms of this warranty, then all costs and expenses in connection with the processing of the Purchaser's claim and all costs for repair, parts and labor as authorized by owner hereunder shall be borne by the purchaser.

RESPONSIBILITY OF THE PURCHASER

The original Purchaser's sole responsibility in the instance of a warranty claim shall be to notify Q.E.D. of the defect, malfunction, or other manner in which the terms of this warranty are believed to be violated. You may secure performance of obligations hereunder by contacting the Customer Service Department of Q.E.D. and:

1. Identifying the product involved (by model or serial number or other sufficient description that will allow Q.E.D. to determine which product is defective).
2. Specifying where, when, and from whom the product was purchased.
3. Describing the nature of the defect or malfunction covered by this warranty.
4. Sending the malfunctioning component, after authorization by Q.E.D. to:

**QED Environmental Systems
6155 Jackson Rd.
Ann Arbor, Michigan 48103**

Appendix

Appendix 1 ID Data Table

NOTE: Bold Shaded values are default for that CPM

CYCLES / min (CPM)																	
1 / min			2 / min			3 / min			4 / min			5 / min			6 / min		
ID	Disch (sec)	Refill (sec)	ID	Disch (sec)	Refill (sec)	ID	Disch (sec)	Refill (sec)	ID	Disch (sec)	Refill (sec)	ID	Disch (sec)	Refill (sec)	ID	Disch (sec)	Refill (sec)
1	1	59	41	1	29	66	1	19	95	1	14	114	1	11	145	1	9
2	2	58	42	2	28	67	1.5	18.5	96	1.5	13.5	115	1.2	10.8	146	1.2	8.8
3	3	57	43	3	27	68	2	18	97	2	13	116	1.4	10.6	147	1.4	8.6
4	4	56	44	4	26	69	2.5	17.5	98	2.5	12.5	117	1.6	10.4	148	1.6	8.4
5	5	55	45	5	25	70	3	17	99	3	12	118	1.8	10.2	149	1.8	8.2
6	6	54	46	6	24	71	3.5	16.5	100	3.5	11.5	119	2	10	150	2	8
7	7	53	47	7	23	72	4	16	101	4	11	120	2.2	9.8	151	2.2	7.8
8	8	52	48	8	22	73	4.5	15.5	102	4.5	10.5	121	2.4	9.6	152	2.4	7.6
9	9	52	49	9	21	74	5	15	103	5	10	122	2.6	9.4	153	2.6	7.4
10	10	50	50	10	20	75	5.5	14.5	104	5.5	9.5	123	2.8	9.2	154	2.8	7.2
11	11	49	51	11	19	76	6	14	105	6	9	124	3	9	155	3	7
12	12	48	52	12	18	77	6.5	13.5	106	6.5	8.5	125	3.2	8.8	156	3.2	6.8
13	13	47	53	13	17	78	7	13	107	7	8	126	3.4	8.6	157	3.4	6.6
14	14	46	54	14	16	79	7.5	12.5	108	7.5	7.5	127	3.6	8.4	158	3.6	6.4
15	15	45	55	15	15	80	8	12	109	8	7	128	3.8	8.2	159	3.8	6.2
16	16	44	56	16	14	81	8.5	11.5	110	8.5	6.5	129	4	8	160	4	6
17	17	43	57	17	13	82	9	11	111	9	6	130	4.2	7.8	161	4.2	5.8
18	18	42	58	18	12	83	9.5	10.5	112	9.5	5.5	131	4.4	7.6	162	4.4	5.6
19	19	41	59	19	11	84	10	10	113	10	5	132	4.6	7.4	163	4.6	5.4
20	20	40	60	20	10	85	10.5	9.5				133	4.8	7.2	164	4.8	5.2
21	21	39	61	21	9	86	11	9				134	5	7	165	5	5
22	22	38	62	22	8	87	11.5	8.5				135	5.2	6.8			
23	23	37	63	23	7	88	12	8				136	5.4	6.6			
24	24	36	64	24	6	89	12.5	7.5				137	5.6	6.4			
25	25	35	65	25	5	90	13	7				138	5.8	6.2			
26	26	34				91	13.5	6.5				139	6	6			
27	27	33				92	14	6				140	6.2	5.8			
28	28	32				93	14.5	5.5				141	6.4	5.6			
29	29	31				94	15	5				142	6.6	5.4			
30	30	30										143	6.8	5.2			
31	31	29										144	7	5			
32	32	28															
33	33	27															
34	34	26															
35	35	25															
36	36	24															
37	37	23															
38	38	22															
39	39	21															
40	40	20															



P.O. Box 3726 Ann Arbor, MI 48106-3726 USA
1-800-624-2026 Fax (734) 995-1170
info@qedenv.com www.qedenv.com