

## Models/Modelos/Modèles

SVB-E8, SVB-E8-2, SVB-E8EC, SVB-E8EXP,  
SVB-A8, SVB-G8, SVB-G8P, SVB-E8CUP, SVB-E8SCUP,  
SVB-E82CUP, SVB-G8CUP, SVB-A8CUP, &  
SVB-E8XCUP

Manual No. BLWR001  
(Rev 4 April 2010)



# Operating Manual Manual de instrucciones Manuel d'utilisation



**TTT Environmental**  
Instruments and Supplies

*The preferred source for instrument  
Rentals, Sales, Service and Supplies!*

4201 B Street  
Anchorage, AK 99503  
(907) 770-9041

[www.tttenviro.com](http://www.tttenviro.com)

25420 74<sup>th</sup> Avenue S.  
Kent, WA 98032  
(253) 373-9041

[info@tttenviro.com](mailto:info@tttenviro.com)

## **AIRSYSTEMS INTERNATIONAL, INC.**

829 Juniper Crescent, Chesapeake, Va. , 23320

Telephone (757) 424-3967

Toll Free 1-800-866-8100

Fax No. (757) 424-5348

<http://www.airsystems.com>

e-mail: [sales@airsystems.com](mailto:sales@airsystems.com)



# Table of Contents

<b>SAFETY PRECAUTIONS.....</b>	<b>3</b>
<b>SADDLEVENT® VENTILATION SETUP.....</b>	<b>3</b>
<b>MODELS SVB-E8, SVB-E8-2, &amp; SVB-E8EC.....</b>	<b>4-5</b>
<b>MODEL SVB-E8EXP.....</b>	<b>6-7</b>
<b>MODEL SVB-A8.....</b>	<b>8-11</b>
<b>MODELS SVB-G8 &amp; SVB-G8P.....</b>	<b>12-14</b>
<b>ESTIMATING PURGE TIMES.....</b>	<b>15</b>
<b>WARRANTY DISCLAIMER.....</b>	<b>42</b>

This series of portable ventilation blowers has been designed for industrial heavy duty applications in confined space ventilation. These blowers are the primary tool for providing fresh clean ventilation air to remote work locations. Each work environment should be thoroughly evaluated by a competent person before selecting the proper blower for a particular application.

 **SAFETY PRECAUTIONS:**  
**READ AND FOLLOW ALL INSTRUCTIONS**

All ventilation procedures should comply with federal, state, and local regulations. Air quality should be tested prior to ventilating a confined space. A purge chart is provided on the ventilation equipment to help assist in estimating the approximate time needed to ventilate confined spaces. Air quality should be tested continuously during confined space occupancy to ensure a stable atmosphere and worker safety because atmospheric conditions can change rapidly. Additional procedures and recommendations are available from federal, state, and local agencies. **DO NOT operate these blower units with the flange or grills removed. DO NOT USE STANDARD ELECTRIC, GASOLINE, OR PROPANE BLOWERS IF VOLATILE OR EXPLOSIVE VAPORS ARE SUSPECTED!**

**Typical Saddle Vent® Setup Procedure**

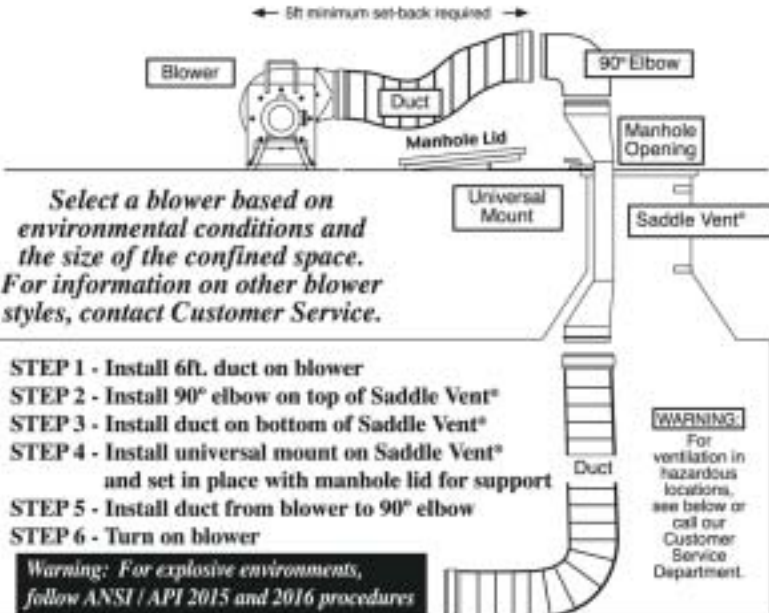

← 5ft minimum set-back required →

Blower, Duct, Manhole Lid, 90° Elbow, Manhole Opening, Universal Mount, Saddle Vent®, Duct

*Select a blower based on environmental conditions and the size of the confined space. For information on other blower styles, contact Customer Service.*

**STEP 1 - Install 6ft. duct on blower**  
**STEP 2 - Install 90° elbow on top of Saddle Vent®**  
**STEP 3 - Install duct on bottom of Saddle Vent®**  
**STEP 4 - Install universal mount on Saddle Vent® and set in place with manhole lid for support**  
**STEP 5 - Install duct from blower to 90° elbow**  
**STEP 6 - Turn on blower**

**WARNING:** For ventilation in hazardous locations, see below or call our Customer Service Department.

**Warning:** For explosive environments, follow ANSI / API 2015 and 2016 procedures

**WARNING: HAZARDOUS LOCATION OPERATIONS**  
Use an explosion-proof blower, conductive ducting, and the conductive Saddle Vent® system. Attach all grounding wires and assure a complete circuit to the blower in order to remove static charges.

Manufactured in the U.S.A. by:  
Air Systems International, Inc.  
821 Juniper Crescent  
Chesapeake, VA 23320

Visit us on-line  
[www.airsystems.cc](http://www.airsystems.cc)



Customer Service:  
TOLL FREE  
1-800-866-8100  
(757) 424-3957  
TOLL FREE FAX  
1-800-247-5950  
(757) 424-5348

Saddle Vent® is covered by U.S. and foreign Patents

## GENERAL SETUP & OPERATION, ELECTRIC BLOWER SERIES

### MODELS SVB-E8, SVB-E8-2, & SVB-E8EC

#### STEP 1)

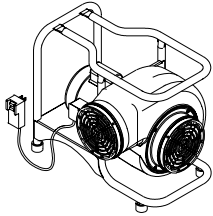

Place blower in a clean fresh air environment. Set blower a minimum of 5 ft. from the manhole opening. *Note: Inspect blower for damaged or worn parts. Inspect all ducting and couplings for possible air leaks prior to blower operation.*

*Note: Air quality of the confined space should be tested prior to ventilation. If air quality of the confined space is unacceptable, consult a trained professional.*

#### STEP 2)

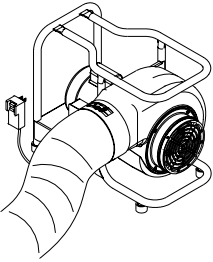

Install duct cuff to exhaust flange and tighten cinch strap. Keep bends and kinks in ducting to a minimum to maximize air flow.

#### STEP 3)

Connect to 120 VAC, 15 amp, 60Hz dedicated service. All standard electric blowers listed are supplied with GFI plug (Ground Fault Interrupters) per the 1996 NEC code requirement: Section 305-6.

*Note: If an extension cord is required, the minimum recommended size is 12 AWG (Maximum 100 ft.). For further information, refer to the National Electric Code Tables, Article 400. (The use of generators are not recommended unless they are of sufficient output capacity. Some generator's output current will not allow the use of GFI plugs. A standard 3-prong plug would need to be installed instead of the GFI receptacle).*

**STEP 4)** Push “on/off” (reset) switch, located on the GFI unit, to the “on” position. The unit is now operational.

### SHUTDOWN

- Insure that all workers are removed from the confined space site.
- Shut off blower and remove all ducting.

### MAINTENANCE

- Keep blower motor dry and free from contaminants and dust.
- Check periodically to ensure moving parts are free from obstructions.

### TROUBLESHOOTING

PROBLEM	POSSIBLE CAUSE	SOLUTION
Excessive vibration	Air intake blocked	Turn blower off and clear debris from intake
	Possible internal damage	Turn blower off and inspect fan blades, shaft, and housing for debris, damage, and loose screws.
	Possible external damage	Turn fan off and inspect blower housing
Blower will not start	Circuit breaker trips	Wattage output of power source insufficient*
		Extension cord improperly sized
	Faulty wall outlet	Test voltage with meter
<i>*Note: The use of generators are not recommended unless they are of sufficient output capacity.</i>		

### MODEL SVB-E8 - Single Speed Electric Blower

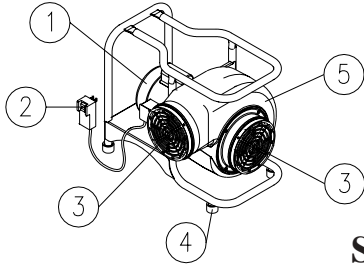

ITEM #	DESCRIPTION	PART #
1	SINGLE SPEED MOTOR	MTR002
2	GFI POWER CORD	ELCB013
3	INTAKE/DISCHARGE GUARD	SVB-DGRD
4	RUBBER FOOT	HDWR025
5	WHEEL HOUSING	SVB-WH
6*	BLOWER WHEEL	METL039

\* LOCATED INSIDE WHEEL HOUSING

#### SPECIFICATIONS

<b>MOTOR TYPE</b>	3/4 HP (.56 kw) Electric, 115 VAC/60Hz, Single Speed, GFI Cord Installed
<b>FULL LOAD AMPERAGE</b>	11.2 Amps
<b>FLOW RATE</b>	Free Air: 1570 cfm 25 ft. Duct with One 90 degree bend: 1047cfm
<b>INLET/ OUTLET SIZE</b>	8" Diameter (203 mm)
<b>WEIGHT</b>	53 lbs.
<b>NOISE LEVEL</b>	76 dbA @ 3 ft.

### MODEL SVB-E8 - 2 Speed Electric Blower

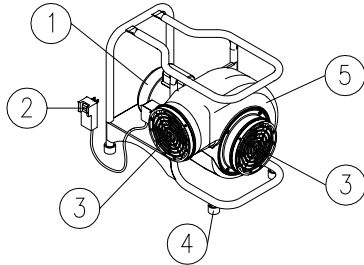

ITEM #	DESCRIPTION	PART #
1	2 - SPEED MOTOR	MTR021
2	GFI POWER CORD	ELCB013
3	INTAKE/DISCHARGE GUARD	SVB-DGRD
4	RUBBER FOOT	HDWR025
5	WHEEL HOUSING	SVB-WH
6*	BLOWER WHEEL	METL039

\* LOCATED INSIDE WHEEL HOUSING

#### SPECIFICATIONS

<b>MOTOR TYPE</b>	3/4 HP (.56 kw) Electric, 115 VAC/60Hz, Dual Speed, GFI Cord Installed
<b>FULL LOAD AMPERAGE</b>	11.5 Amps
<b>FLOW RATES</b>	Free Air: 750 Low/1570 High 25 ft. Duct with One 90 degree bend: 490 Low/1047 High
<b>INLET/ OUTLET SIZE</b>	8" Diameter (203 mm)
<b>WEIGHT</b>	58 lbs.
<b>NOISE LEVEL</b>	76dbA @ 3 ft. High

### MODEL SVB-E8EC - Economy Electric Blower

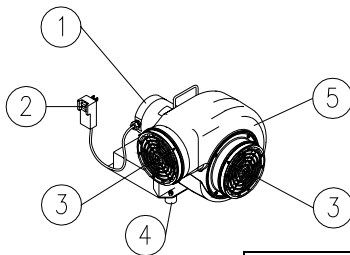

ITEM #	DESCRIPTION	PART #
1	SINGLE SPEED MOTOR	MTR040
2	GFI POWER CORD	ELCB013
3	INTAKE/DISCHARGE GUARD	SVB-DGRD
4	RUBBER FOOT	HDWR025
5	WHEEL HOUSING	SVB-WH
6*	BLOWER WHEEL	METL039

\* LOCATED INSIDE WHEEL HOUSING

#### SPECIFICATIONS

<b>MOTOR TYPE</b>	1/2 HP (.37 kw) Electric, 115 VAC/60Hz, Single Speed, GFI Cord Installed
<b>FULL LOAD AMPERAGE</b>	7.9 Amps
<b>FLOW RATES</b>	Free Air: 1390 cfm 25 ft. Duct with One 90 degree bend: 973 cfm
<b>INLET/ OUTLET SIZE</b>	8" Diameter (203 mm)
<b>WEIGHT</b>	37 lbs.
<b>NOISE LEVEL</b>	76dbA @ 3 ft.

# GENERAL SETUP & OPERATION, EXPLOSION-PROOF ELECTRIC BLOWER MODEL SVB-E8EXP

## STEP 1)

Place blower in a clean fresh air environment. Set blower a minimum of 5 ft. from the manhole opening. *Note: Inspect blower for damaged or worn parts. Inspect all ducting and couplings for possible air leaks prior to blower operation.*

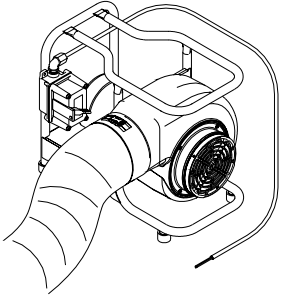

### CAUTION:

*Air quality of the confined space should be tested prior to ventilation. If air quality of the confined space is unacceptable, consult a trained professional.*

## STEP 2)

Install duct cuff to exhaust flange and tighten cinch strap. Keep bends and kinks in ducting to a minimum to maximize air flow. **THE USE OF CONDUCTIVE DUCTING IS RECOMMENDED WHEN OPERATING IN POTENTIALLY EXPLOSIVE ENVIRONMENTS.**

**ASSURE THAT THE BLOWER IS PROPERLY GROUNDED BEFORE OPERATING AND THAT THE GROUNDING WIRE, IN THE CONDUCTIVE DUCTING IS ATTACHED TO THE BLOWER AND SADDLE VENT®, IF USED.**

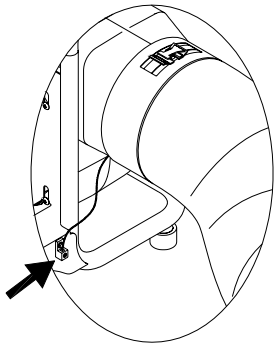

**Grounding lug provided for ground wire attachment from conductive duct.**

### CAUTION:

If explosive or volatile vapors are suspected or present, follow ANSI/API procedure 2015 and 2016 for proper grounding of the blower. All static electricity must be removed from the blower and attached ducting prior to energizing the blower. Conductive ducting should be tested semi-annually to assure resistance (ohms) does not exceed 300k. If sufficient resistance is not achieved, the duct should be removed from service.

## STEP 3)

Explosion-proof models should be fitted with an approved explosion-proof plug to meet Class I, Div. I, Groups C and D, Class II, Div. I, Groups E, F, G specifications. The plug should not be disconnected or connected in an explosive environment when the blower is energized.

**STEP 4)** Switch the explosion-proof “on/off” switch to the “on” position. The unit is now operational.

## SHUTDOWN

- Insure that all workers are removed from the confined space site.
- Shut off blower and remove all ducting.

## MAINTENANCE

- Keep blower motor dry and free from contaminants and dust.
- Check periodically to ensure moving parts are free from obstructions.

## TROUBLESHOOTING

PROBLEM	POSSIBLE CAUSE	SOLUTION
Excessive vibration	Air intake blocked	Turn blower off and clear debris from intake
	Possible internal damage	Turn blower off and inspect fan blades, shaft, and housing for debris, damage, and loose screws.
	Possible external damage	Turn fan off and inspect blower housing
Blower will not start	Circuit breaker trips	Wattage output of power source insufficient*
		Extension cord improperly sized
	Faulty wall outlet	Test voltage with meter

*\*Note: The use of generators are not recommended unless they are of sufficient output capacity.*

## MODEL SVB-E8EXP- Explosion-Proof Electric Blower

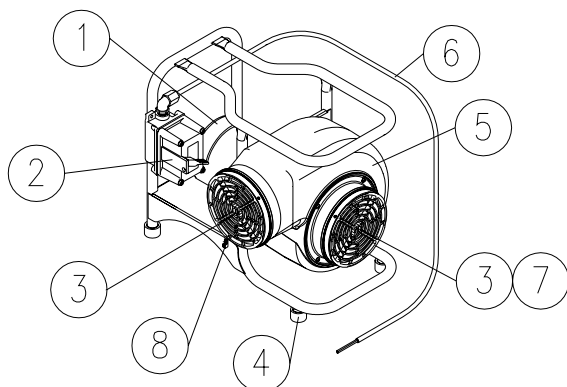

ITEM #	DESCRIPTION	PART #
1	EXPLOSION PROOF MOTOR	MTR003
2	EXPLOSION PROOF ON/OFF SWITCH	ELSW028
3	INTAKE/DISCHARGE GUARD - CONDUCTIVE	SVB-DGRDCN
4	RUBBER FOOT	HDWR025
5	WHEEL HOUSING - CONDUCTIVE	SVB-WH-CND
6	POWER CORD	ELCB011-25
7*	BLOWER WHEEL (SET SCREWS - FS5/16X038)	METL039
8	GROUND LUG	ELA051

\* LOCATED INSIDE WHEEL HOUSING



## SPECIFICATIONS

<b>MOTOR TYPE</b>	3/4 HP (.56 kw) Electric, 115 VAC/60Hz, factory wired with 25ft. Cord, no plug, explosion-proof Class I, Div 1, Groups C and D, Class II, Div. 1, Groups E,F,G
<b>FULL LOAD AMPERAGE</b>	12.6 Amps
<b>FLOW RATES</b>	Free Air: 1570 cfm 25 ft. Duct with One 90 degree bend: 1047cfm
<b>INLET/ OUTLET SIZE</b>	8" Diameter (203 mm)
<b>WEIGHT</b>	68 lbs.
<b>SWITCH TYPE</b>	Explosion-proof
<b>NOISE LEVEL</b>	76dbA @ 3 ft.

### **⚠ WARNING:**

**FOR HAZARDOUS ENVIRONMENTS, ALWAYS USE AIR SYSTEMS' MODEL SV-CUPCND CONDUCTIVE SADDLE VENT® VENTILATION KIT WITH AN EXPLOSION-PROOF OR PNEUMATIC BLOWER.**

# GENERAL SETUP & OPERATION, PNEUMATIC BLOWER

## MODEL SVB-A8

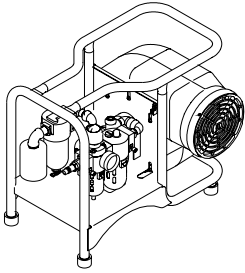

### STEP 1)

Operate blower in vertical position only. Place in a clean fresh air environment away from toxic gases and dust. Set blower a minimum of 5 ft. from the manhole opening. **Note: Inspect blower for damaged or worn parts. Inspect all ducting and couplings for possible air leaks prior to blower operation.**

**Note: Air quality of the confined space should be tested prior to ventilation. If air quality of the confined space is unacceptable, consult a trained professional.**

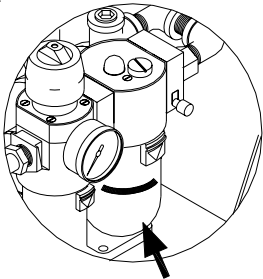

### STEP 2)

Attach and tighten the filter/regulator and lubricator assembly. Make sure oil level in the lubricator is at the full mark (approximately 3/4 of bowl height); add additional oil if necessary. Factory recommended oil is SAE #10 automotive engine oil or lighter. (Petroleum based only, do not use synthetic oils.)

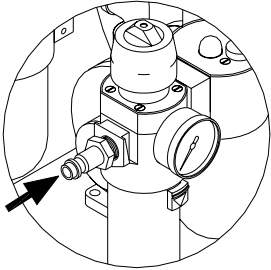

### STEP 3)

Secure a primary air source with a flow capacity of 10 - 100cfm and a pressure range of 10 - 100psi. Attach a minimum 1/2" I.D hose to the inlet fitting. Note: Maximum inlet pressure should not exceed 150psi (10 bar).

### STEP 4)

Install duct cuff to exhaust flange and tighten cinch strap. Keep bends and kinks in ducting to a minimum to maximize air flow. **THE USE OF CONDUCTIVE DUCTING IS RECOMMENDED WHEN OPERATING IN POTENTIALLY EXPLOSIVE ENVIRONMENTS. Assure that the blower is properly grounded before operating and that the grounding wires from the ducting and Saddle Vent®, if used are securely attached to the blower's grounding wire.**

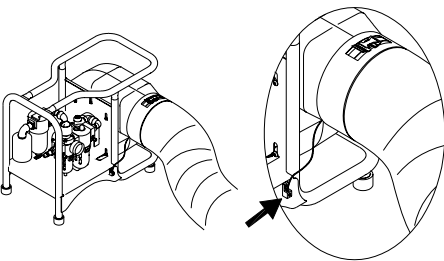

### ⚠ CAUTION:

If explosive or volatile vapors are suspected or present, follow ANSI/ API 2015 and 2016 procedures for proper grounding of the blower. All static electricity must be removed from the blower and attached ducting prior to energizing the blower.

Conductive ducting should be tested semiannually to assure resistance (ohms) does not exceed 300k. If sufficient resistance is not achieved, the duct should be removed from service.

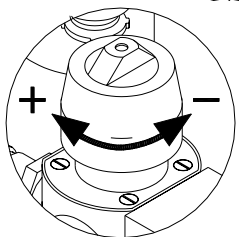

### STEP 5)

Adjust pressure regulator, clockwise to increase, counterclockwise to decrease motor speed. This adjustment will increase or decrease the air flow. **Note: Available air pressure (psi) and volume (cfm) will determine blower performance.**



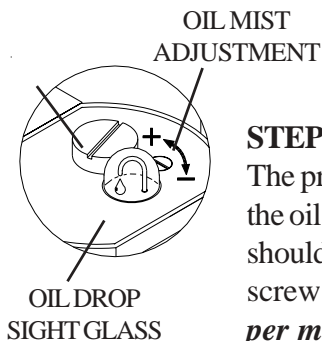

**STEP 6)**

The proper amount of oil mist has already been factory preset. However, depending on the viscosity of the oil being used, slight adjustments may be necessary. With the blower running, the proper oil mist should be one drop/min. The oil mist adjustment screw is located next to the oil fill cap. Turn this screw clockwise to decrease or counterclockwise to increase oil flow. **Note: *Approximately 1 drop per minute can be achieved by turning the adjustment screw fully clockwise and then turn counterclockwise 1 1/2 turns.***

**SHUTDOWN**

- Insure that all workers are removed from the confined space site.
- Shut off blower and remove all ducting.

**MAINTENANCE**

- Keep blower motor dry and free from contaminants and dust.
- Check periodically to ensure moving parts are free from obstructions.
- Change filter (Part# WL040B) located in regulator after approximately 300 - 500 hours
- Use SAE #10 automotive engine oil or lighter in lubricator at all times. (Do not exceed 10 weight oil). Heavy weight oils will cause damage to the air motor.
- Clean muffler assembly every 100-300 hours with safety solvent (Part #BAC-1001).
- Flush air motor every 100 hours with safety solvent (#BAC-1001) through maintenance port (see below).
- Remove air exhaust filter before flushing and reinstall after several minutes of running unit. Flush unit after every 200 hours or after storing for long periods.

**AIR MOTOR FLUSHING PROCEDURE**

Use Air Systems' Part #BAC-1001 safety solvent.

Do not use a flammable solvent or a solvent with a toxicity rating of 500ppm or greater to flush the unit.

**Note: *Eye protection should be worn when flushing the unit.***

**STEP 1)**

To flush the motor, turn off blower and remove the exhaust filter element (See page 10).

MAINTENANCE PORT

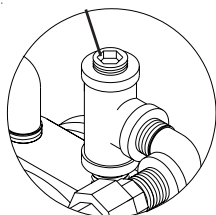

**STEP 2)**

Open the maintenance port, shown at left. Spray one or two ounces of safety solvent into the maintenance port. Close the maintenance port. Run the blower in an open area away from sparks and flames for a minimum of five minutes before reinstalling the exhaust filter.

# TROUBLESHOOTING

PROBLEM	POSSIBLE CAUSE	SOLUTION
Blower will not start	Insufficient pressure	Check pressure gauge on compressed air source to ensure proper supply pressure. Turn regulator knob clockwise to increase air pressure to air motor and note the gauge pressure on the regulator.
Excessive vibration	Possible internal damage	Turn blower off and inspect fan blades, shaft, and housing for debris, damage, and loose screws. <i>Note: Never run blower for extended periods without installing duct on the exhaust flange.</i>
	Possible external damage	Turn blower off and inspect housing
Blower loses pressure	Insufficient air flow or pressure	Hose with a minimum 1/2" diameter is required at 10-100cfm delivery volume
		Remove muffler housing and unscrew internal air muffler. Clean with safety solvent and reinstall.
Motor icing (interior)	Excessive water in airline	Install moisture separator filter before blower (order Model #PF-240). Remove muffler and clean out ice blockage and reassemble.
Motor icing (exterior)	Very high humidity	Normal during hot weather

## MODEL SVB-A8 Pneumatic Blower

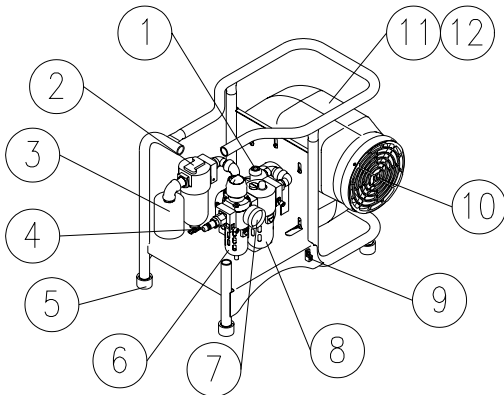

ITEM #	DESCRIPTION	PART #
1	MAINTENANCE PORT	ST8PLA
2	EXHAUST FILTER ELEMENT	WL008A
3	MUFFLER	COMPAA001
4	INLET FITTING	QDH5PL8M
5	RUBBER FOOT	HDWR025
6	FILTER/REGULATOR	WL040
7	PRESSURE GAUGE	GA20160B
8	LUBRICATOR	WL020
9	GROUND LUG	ELA051
10	INTAKE/DISCHARGE GUARD - CONDUCTIVE	SVB-DGRDCN
11	WHEEL HOUSING - CONDUCTIVE	SVB-WH-CND
12*	BLOWER WHEEL (SET SCREWS - FS5/16X038)	METL039

\*LOCATED INSIDE WHEEL HOUSING



## SPECIFICATIONS

<b>MOTOR TYPE</b>	4 HP (3.0 kw) pneumatic (Intrinsically safe)
<b>FUNCTIONAL COMPONENTS</b>	1st Stage: Particulate/water filter with combination air pressure regulator and gauge, 2nd stage: In-line lubricator, discharge exhaust oil filter and noise suppressing muffler.
<b>PRESSURE REQUIRED</b>	10-100psi
<b>AIR CONSUMPTION</b>	10-100cfm
<b>FLOW RATES</b>	Free Air: 1500 at minimum psi and cfm - 3000 at maximum psi and cfm 25 ft. Duct with One 90 degree bend: 1040 at minimum psi and cfm 1725 at maximum
<b>INLET/ OUTLET SIZE</b>	8" Diameter (203 mm)
<b>NOISE LEVEL</b>	82dbA at 3 ft. @ 80psi inlet pressure

# MODEL SVB-A8 BLOWER COMPONENTS AND PARTS ASSEMBLY

FILTER/REGULATOR

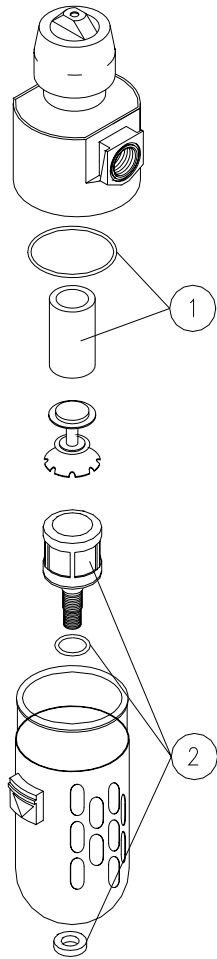

LUBRICATOR

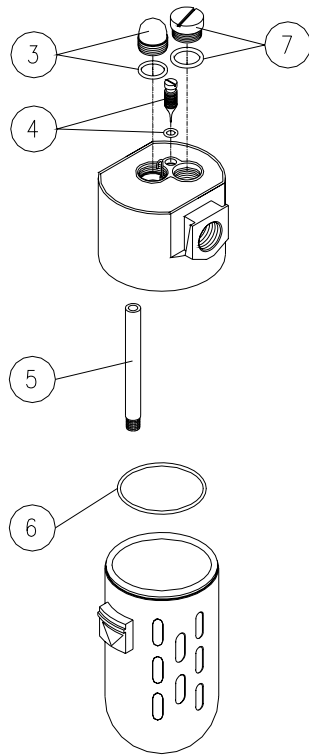

EXHAUST FILTER

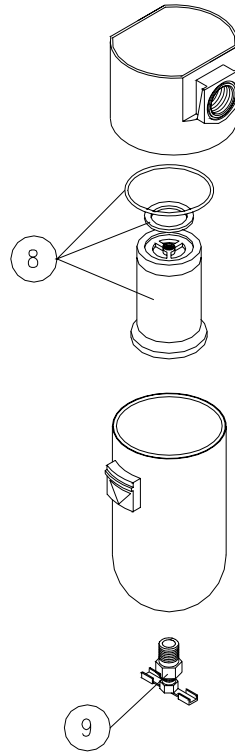

MUFFLER ASSEMBLY

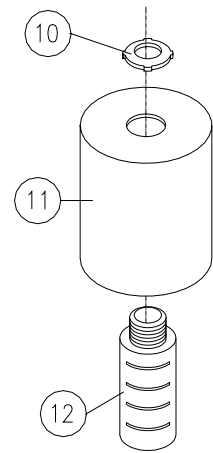

# GENERAL SETUP & OPERATION, GASOLINE AND PROPANE BLOWER SERIES MODEL SVB-G8 & SVB-G8P

 **CAUTION:**

*Gasoline engines produce carbon monoxide. The exhaust snorkel **MUST** be used while operating this blower. Do not operate gas or propane blowers in explosive or potentially hazardous environments.*

***All new gasoline and propane blowers must be run for 30 minutes to burn off residual oils and paint residue before placing them into service.***

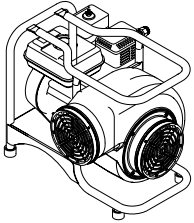

**STEP 1)**

Operate blower in the vertical position only. Place in a clean fresh air environment away from toxic gases and dust. Set blower a minimum of 5 ft. from the manhole opening. **Note: Inspect blower for damaged or worn parts. Inspect all ducting and couplings for possible air leaks prior to blower operation.**

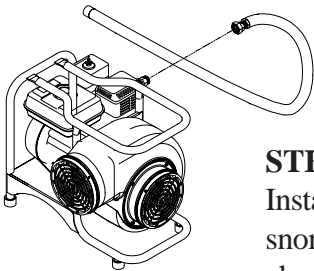

***Note: Air quality of the confined space should be tested prior to ventilation. If air quality of the confined space is unacceptable, consult a trained professional.***

**STEP 2)**

Install exhaust hose assembly securely to pipe union on the engine muffler. Locate end of exhaust snorkel down wind and away from blower intake and manhole area as shown below. Periodically check muffler union to assure a tight connection. **DO NOT PICK UP BLOWER USING MUFFLER ASSEMBLY AS A HANDLE!! SEVERE BURNS MAY RESULT!!**

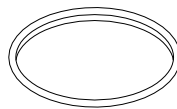
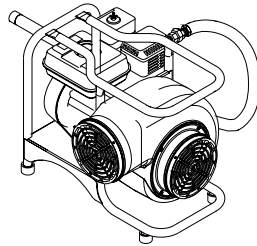

**CORRECT**

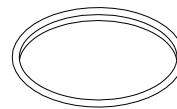
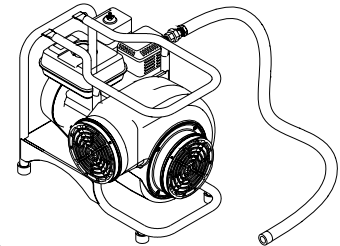

**INCORRECT**

**STEP 3)**

Install duct cuff to exhaust flange and tighten cinch strap. Keep bends and kinks in ducting to a minimum to maximize air flow. **DO NOT** run gasoline or propane blowers without attaching ventilation ducting as excessive vibration may cause blower damage.

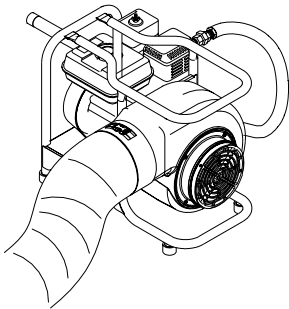

**STEP 4) ENGINE START UP**

Check engine oil level prior to operation. (Fill to proper level if necessary). **DO NOT** overfill.

**STEP 5)**

**For Propane Models**, connect regulator to propane tank as shown at left. Propane gas models are supplied with a liquid propane conversion kit. **DO NOT** substitute components or regulation device.

**For Gasoline Models**, check fuel level and fill with unleaded gasoline. **Note: Allow engine to cool before refueling.**

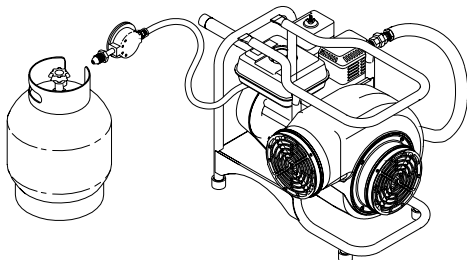

**STEP 6)**

Check engine intake filter periodically and replace if necessary.

**STEP 7)**

Review and follow ALL safety precautions and run procedures found in the enclosed Briggs and Stratton/Honda manual prior to starting. (Some gasoline units are supplied with Honda engines as an option, Model SVB-G8H.)

**STEP 8)**

Start engine by placing the throttle adjustment at idle and choke adjustment at “START” position. Pull start cord. Once started, return choke to “RUN” position.

**SHUTDOWN**



**CAUTION:**

*Allow exhaust snorkel pipe to cool before removing from engine.  
Heat resistant gloves are recommended when handling the exhaust hose.*

- Insure that all workers are removed from the confined space site.
- Shut off blower. Do not move choke control to CHOKE to stop engine; backfire or engine damage may occur. Move throttle control to “SLOW” position; then move stop control to “STOP” position.

**MAINTENANCE**

*Note: All maintenance should be completed with unit switched off and cooled down.*

- Keep blower motor dry and free from contaminants and dust. Engines stored over 30 days need to be protected or drained of fuel to prevent gum from forming in fuel system.
- Check oil level and intake filters regularly. Be sure oil level is full and filters are well maintained. Check oil level every 5 hours or daily before starting engine.

**TROUBLESHOOTING**

PROBLEM	POSSIBLE CAUSE	SOLUTION
Excessive vibration	Air intake blocked	Turn blower off and clear debris from intake
	Possible internal damage	Turn blower off and inspect fan blades, shaft, and housing for debris, damage, and loose screws. <i>Note: Never run blower without installing duct on the exhaust flange.</i>
	Possible external damage	Turn fan off and inspect housing
Engine will not start	No fuel	Refuel
	Check choke settings	Check propane hose connection
	Fouled or faulty spark plug	Remove, clean, re-gap, or replace spark plug

## MODEL SVB-G8 - Gasoline Blower

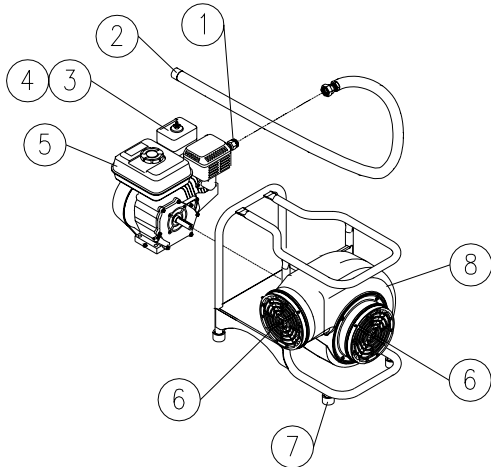

ITEM #	DESCRIPTION	PART #
1	MUFFLER ASSEMBLY	SVB-G8MNS
2	MUFFLER HOSE	SVB-G8MHNS
3	INTAKE FILTER	MTRA002
4	INTAKE PREFILTER	MTRA001
5	GAS MOTOR	MTR011
6	INTAKE/DISCHARGE GUARD	SVB-DG
7	RUBBER FOOT	HDWR025
8	WHEEL HOUSING	SVB-WH
9*	BLOWER WHEEL	METL039A
	*LOCATED INSIDE WHEEL HOUSING	



### SPECIFICATIONS

<b>MOTOR TYPE</b>	3.5 HP (2.6 kw) Briggs/Stratton (Standard) 4.0 HP (3 kw) Honda Gasoline (Optional)
<b>FUEL</b>	Unleaded Regular Gasoline
<b>FUEL CAPACITY</b>	2.5 Hours
<b>RUN TIME AT IDLE</b>	
<b>INLET/ OUTLET SIZE</b>	8" Diameter (203 mm)
<b>FLOW RATES</b>	Free Air: 1500 min, 3000cfm max 25 ft. Duct with One 90 degree bend: 1040 Low/1750 High
<b>WEIGHT</b>	47 lbs.
<b>NOISE LEVEL</b>	92.5 dbA at 3 ft.

## MODEL SVB-G8P - Propane Blower

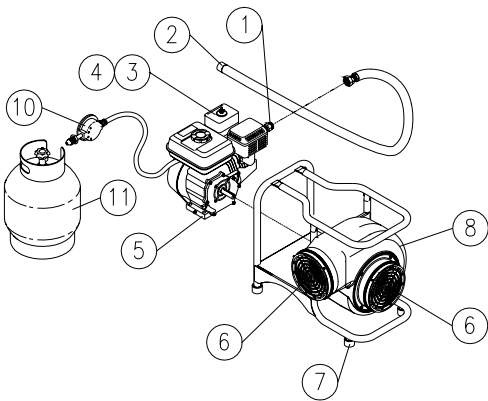

ITEM #	DESCRIPTION	PART #
1	MUFFLER ASSEMBLY	SVB-G8MNS
2	MUFFLER HOSE	SVB-G8MHNS
3	INTAKE FILTER	MTRA002
4	INTAKE PREFILTER	MTRA001
5	GAS MOTOR	MTR011
6	INTAKE/DISCHARGE GUARD	SVB-DG
7	RUBBER FOOT	HDWR025
8	WHEEL HOUSING	SVB-WH
9*	BLOWER WHEEL	METL039A
10	PROPANE ADAPTER KIT	MTR012
	*LOCATED INSIDE WHEEL HOUSING	



### SPECIFICATIONS

<b>MOTOR TYPE</b>	3.5 HP (2.6 kw) Briggs/Stratton
<b>FUEL</b>	Liquid Propane
<b>FUEL CAPACITY</b>	20 lbs./7.45kg 4.2 Hours
<b>RUN TIME AT IDLE</b>	
<b>INLET/ OUTLET SIZE</b>	8" Diameter (203 mm)
<b>FLOW RATES</b>	Free Air: 1500 min 3000cfm max 25 ft. Duct with One 90 degree bend: 1040 Low/1750 High
<b>WEIGHT</b>	47 lbs.
<b>NOISE LEVEL</b>	92.5 dbA at 3 ft.

# ESTIMATING APPROXIMATE PURGE TIMES

## HOW TO USE CHART

- 1) Select the proper size scale at left, high or low, depending on size of confined space.
- 2) Place one end of a straight edge on the proper size scale at left.
- 3) Place other end of straight edge on blower capacity scale at right.
- 4) Read required purge time from the diagonal scale that corresponds to the high or low volume scale selected.

Reference:  
Bell Systems Standard  
ISS 10, Section 620-140-501

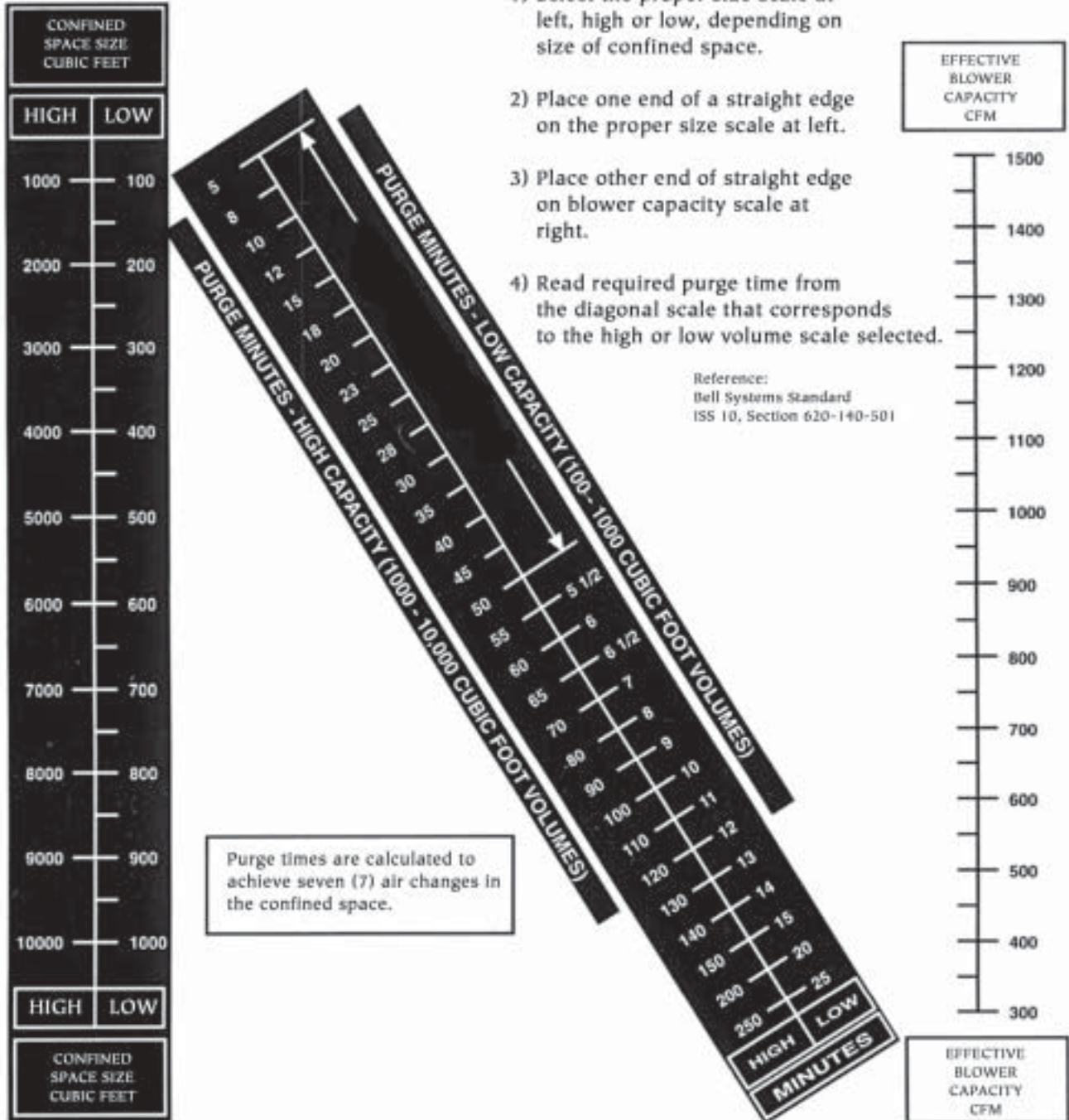

## SPECIAL NOTES

- 1) Air quality of the confined space should be tested prior to ventilation.
- 2) Ventilate confined space for the minimum times as determined in the above chart and then retest air.
- 3) If toxic (combustible) gases or low oxygen is encountered, increase purge times by 50%.
- 4) If 2 blowers are used, add the two capacities, then proceed with the "How to use chart" above.
- 5) Effective blower capacity is measured with one or two 90 degree bends in 8" diameter 25 ft. blower hose.